

SB330-CRM

System Board
User's Manual

Copyright

This publication contains information that is protected by copyright. No part of it may be reproduced in any form or by any means or used to make any transformation/adaptation without the prior written permission from the copyright holders.

This publication is provided for informational purposes only. The manufacturer makes no representations or warranties with respect to the contents or use of this manual and specifically disclaims any express or implied warranties of merchantability or fitness for any particular purpose. The user will assume the entire risk of the use or the results of the use of this document. Further, the manufacturer reserves the right to revise this publication and make changes to its contents at any time, without obligation to notify any person or entity of such revisions or changes.

© 2012. All Rights Reserved.

Trademarks

All trademarks and registered trademarks of products appearing in this manual are the properties of their respective holders.

FCC and DOC Statement on Class B

This equipment has been tested and found to comply with the limits for a Class B digital device, pursuant to Part 15 of the FCC rules. These limits are designed to provide reasonable protection against harmful interference when the equipment is operated in a residential installation. This equipment generates, uses and can radiate radio frequency energy and, if not installed and used in accordance with the instruction manual, may cause harmful interference to radio communications. However, there is no guarantee that interference will not occur in a particular installation. If this equipment does cause harmful interference to radio or television reception, which can be determined by turning the equipment off and on, the user is encouraged to try to correct the interference by one or more of the following measures:

- Reorient or relocate the receiving antenna.
- Increase the separation between the equipment and the receiver.
- Connect the equipment into an outlet on a circuit different from that to which the receiver is connected.
- Consult the dealer or an experienced radio TV technician for help.

Notice:

1. The changes or modifications not expressly approved by the party responsible for compliance could void the user's authority to operate the equipment.
2. Shielded interface cables must be used in order to comply with the emission limits.

Table of Contents

Copyright.....	2
Trademarks.....	2
FCC and DOC Statement on Class B.....	3
About this Manual.....	6
Warranty.....	6
Static Electricity Precautions.....	7
Safety Measures.....	7
About the Package.....	8
Before Using the System Board.....	8
Chapter 1 - Introduction.....	9
Specifications.....	9
Features.....	11
Chapter 2 - Hardware Installation.....	15
System Board Layout.....	15
System Memory.....	16
Installing the DIM Module.....	18
CPU.....	20
Installing the CPU.....	21
Installing the Fan and Heat Sink.....	25
Jumper Settings.....	27
Clear CMOS Data.....	27
PS/2 Power Select.....	28
USB Power Select.....	29
Power-on Select.....	30
COM1/COM2 RS232/RS422/RS485 Select.....	31
COM1/COM2 RS232/Power Select.....	32
Rear Panel I/O Ports.....	33
PS/2 Mouse and PS/2 Keyboard Ports.....	34
COM (Serial) Ports.....	35
VGA Port.....	36
DVI-I Port.....	37
RJ45 LAN Ports.....	38
USB Ports.....	39
Audio.....	41

I/O Connectors	43
CD-in Internal Audio Connector	43
S/PDIF Connector.....	44
Digital I/O Connectors	45
SATA (Serial ATA) Connectors	46
Cooling Fan Connectors.....	47
Chassis Intrusion Connector	48
Power Connectors	49
Standby Power LED	50
Front Panel Connectors	51
Expansion Slots	52
Battery	53
Chapter 3 - BIOS Setup	54
Overview	54
AMI BIOS Setup Utility	56
Main	56
Advanced	57
Chipset	71
Boot	78
Security	80
Save & Exit	81
Updating the BIOS.....	82
Chapter 4 - Supported Software	83
Chapter 5 - RAID	110
RAID Levels	110
Settings.....	111
Chapter 6 - Intel AMT Settings	116
Overview	116
Enable Intel® AMT in the AMI BIOS.....	117
Enable Intel® AMT in the Intel® Management Engine BIOS Extension (MEBX) Screen	120
Appendix A - NLITE and AHCI Installation Guide	149
Appendix B - Watchdog Sample Code	161
Appendix C - System Error Message	162
Appendix D - Troubleshooting	164

About this Manual

This manual can be downloaded from the website, or acquired as an electronic file included in the optional CD/DVD. The manual is subject to change and update without notice, and may be based on editions that do not resemble your actual products. Please visit our website or contact our sales representatives for the latest editions.

Warranty

1. Warranty does not cover damages or failures that arised from misuse of the product, inability to use the product, unauthorized replacement or alteration of components and product specifications.
2. The warranty is void if the product has been subjected to physical abuse, improper installation, modification, accidents or unauthorized repair of the product.
3. Unless otherwise instructed in this user's manual, the user may not, under any circumstances, attempt to perform service, adjustments or repairs on the product, whether in or out of warranty. It must be returned to the purchase point, factory or authorized service agency for all such work.
4. We will not be liable for any indirect, special, incidental or consequential damages to the product that has been modified or altered.

Static Electricity Precautions

It is quite easy to inadvertently damage your PC, system board, components or devices even before installing them in your system unit. Static electrical discharge can damage computer components without causing any signs of physical damage. You must take extra care in handling them to ensure against electrostatic build-up.

1. To prevent electrostatic build-up, leave the system board in its anti-static bag until you are ready to install it.
2. Wear an antistatic wrist strap.
3. Do all preparation work on a static-free surface.
4. Hold the device only by its edges. Be careful not to touch any of the components, contacts or connections.
5. Avoid touching the pins or contacts on all modules and connectors. Hold modules or connectors by their ends.



Important:

Electrostatic discharge (ESD) can damage your processor, disk drive and other components. Perform the upgrade instruction procedures described at an ESD workstation only. If such a station is not available, you can provide some ESD protection by wearing an antistatic wrist strap and attaching it to a metal part of the system chassis. If a wrist strap is unavailable, establish and maintain contact with the system chassis throughout any procedures requiring ESD protection.

Safety Measures

To avoid damage to the system:

- Use the correct AC input voltage range.

To reduce the risk of electric shock:

- Unplug the power cord before removing the system chassis cover for installation or servicing. After installation or servicing, cover the system chassis before plugging the power cord.

Battery:

- Danger of explosion if battery incorrectly replaced.
- Replace only with the same or equivalent type recommend by the manufacturer.
- Dispose of used batteries according to local ordinance.

About the Package

The system board package contains the following items. If any of these items are missing or damaged, please contact your dealer or sales representative for assistance.

- ☑ One system board
- ☑ One PS/2 Keyboard/Mouse cable (optional)
- ☑ Two Serial ATA data cables
- ☑ Two Serial ATA power cables
- ☑ Two USB cables
- ☑ One COM port cable
- ☑ One I/O shield
- ☑ One QR (Quick Reference)

The system board and accessories in the package may not come similar to the information listed above. This may differ in accordance to the sales region or models in which it was sold. For more information about the standard package in your region, please contact your dealer or sales representative.

Before Using the System Board

Before using the system board, prepare basic system components.

If you are installing the system board in a new system, you will need at least the following internal components.

- A CPU
- Memory module
- Storage devices such as hard disk drive, CD-ROM, etc.

You will also need external system peripherals you intend to use which will normally include at least a keyboard, a mouse and a video display monitor.

Chapter 1 - Introduction

Specifications

Processor	<ul style="list-style-type: none">• LGA 1155 socket for:<ul style="list-style-type: none">- 3rd generation Intel® Core™ processors (22nm process technology)<ul style="list-style-type: none">: Intel® Core™ i7-3770 (8M Cache, up to 3.9GHz); 77W: Intel® Core™ i5-3550S (6M Cache, up to 3.7GHz); 65W: Intel® Core™ i3-3220 (3M Cache, 3.3GHz); 55W: Intel® Pentium® G2120 (3M Cache, 3.1 GHz); 65W- 2nd generation Intel® Core™ processors (32nm process technology)<ul style="list-style-type: none">: Intel® Core™ i7-2600 (8M Cache, up to 3.8 GHz); 95W: Intel® Core™ i5-2400 (6M Cache, up to 3.4 GHz); 95W: Intel® Core™ i3-2120 (3M Cache, 3.3 GHz); 65W: Intel® Pentium® G850 (3M Cache, 2.9 GHz); 65W
Chipset	<ul style="list-style-type: none">• Intel® Q67 PCH (Platform Controller Hub)
System Memory	<ul style="list-style-type: none">• Four 240-pin DDR3 DIMM sockets• Supports DDR3 1333/1600MHz (3rd generation processors)• Supports DDR3 1066/1333MHz (2nd generation processors)• Supports dual channel memory interface• Supports up to 32GB system memory• DRAM device technologies: 1Gb, 2GB and 4Gb DDR3 DRAM technologies are supported for x8 and x16 devices, unbuffered, non-ECC
Expansion Slots	<ul style="list-style-type: none">• 1 PCIe x16 slot<ul style="list-style-type: none">- Supports Gen 3.0 (3rd generation processors)- Supports Gen 2.0 (2nd generation processors)• 1 PCI Express x4 slot (PCIe 2.0)• 2 PCI slots(PCI 2.3: supports universal PCI card)
Graphics	<ul style="list-style-type: none">• Intel® HD Graphics• Display ports: DVI-I (DVI-D signal) and VGA• DVI-I supports up to 1920x1200 @ 60Hz resolution• VGA supports up to 2048x1536 @ 75Hz resolution• Supports 6 Graphics Execution Units (EUs)• Intel® Clear Video Technology• DirectX Video Acceleration (DXVA) support for accelerating video processing

Audio	<ul style="list-style-type: none"> • Realtek ALC262 2-channel High Definition Audio • High performance DACs with 100dB SNR • ADCs with 90dB SNR • Two stereo DACs support 24-bit PCM format for stereo audio playback • Three stereo ADCs support 20-bit PCM format for multiple input streaming • S/PDIF audio interface
LAN	<ul style="list-style-type: none"> • Intel 82579LM with iAMT8.0 Gigabit Ethernet Phy • Realtek RTL8111DL PCI Express Gigabit Ethernet controller • Integrated 10/100/1000 transceiver • Fully compliant with IEEE 802.3, IEEE 802.3u, IEEE 802.3ab • Supports wire management
Serial ATA	<ul style="list-style-type: none"> • 6 Serial ATA ports <ul style="list-style-type: none"> - 4 SATA 2.0 ports with data transfer rate up to 3Gb/s (SATA port 4 provides adequate space for SATA DOM) - 2 SATA 3.0 ports with data transfer rate up to 6Gb/s • Integrated Advanced Host Controller Interface (AHCI) controller • Supports RAID 0/1/5/10
Intel Active Management Technology (AMT)	<ul style="list-style-type: none"> • Supports iAMT8.0 • Out-of-band system access • Remote troubleshooting and recovery • Hardware-based agent presence checking • Proactive alerting • Remote hardware and software asset tracking
TPM (optional)	<ul style="list-style-type: none"> • TPM - Trusted Platform Module • Provides a Trusted PC for secure transactions • Provides software license protection, enforcement and password protection
Rear Panel I/O Ports	<ul style="list-style-type: none"> • 1 mini-DIN-6 PS/2 mouse port • 1 mini-DIN-6 PS/2 keyboard port • 2 DB-9 serial ports <ul style="list-style-type: none"> - Supports RS232/422/485 (RS232 and/or Power) • 1 DB-15 VGA port • 1 DVI-I port (DVI-D signal) • 2 RJ45 LAN ports and 4 USB 2.0/1.1 ports • Mic-in, line-in and line out jacks
I/O Connectors	<ul style="list-style-type: none"> • 4 connectors for 8 external USB 2.0/1.1 ports • 4 connectors for 4 external RS232 serial ports • 1 8-bit Digital I/O connector • 1 front audio connector for line-out and mic-in jacks • 1 CD-in connector and 1 S/PDIF connector • 6 Serial ATA ports • 1 24-pin ATX power connector and 1 8-pin 12V power connector • 1 chassis intrusion connector and 1 front panel connector • 2 fan connectors

BIOS	<ul style="list-style-type: none"> • AMI BIOS • 64Mbit SPI BIOS
Energy Efficient Design	<ul style="list-style-type: none"> • Supports ErP Lot6 power saving (optional) • Supports ACPI • System Power Management • Wake-On-Events include: <ul style="list-style-type: none"> - Wake-On-PS/2 KB/Mouse - Wake-On-USB KB/Mouse - Wake-On-LAN - RTC timer to power-on the system • CPU stopped clock control • AC power failure recovery
Damage Free Intelligence	<ul style="list-style-type: none"> • Monitors CPU/system temperature and overheat alarm • Monitors V_{CORE}/5V/3.3V/V_{DIMM}/12V/5V_{SB} voltages and failure alarm • Monitors CPU/system fan speed and failure alarm • Read back capability that displays temperature, voltage and fan speed • Watchdog timer function
Temperature	<ul style="list-style-type: none"> • 0°C to 60°C
Humidity	<ul style="list-style-type: none"> • 10% to 90%
PCB	<ul style="list-style-type: none"> • microATX form factor • 244mm (9.6") x 244mm (9.6")

Features

Watchdog Timer

The Watchdog Timer function allows your application to regularly “clear” the system at the set time interval. If the system hangs or fails to function, it will reset at the set time interval so that your system will continue to operate.

DDR3

DDR3 delivers increased system bandwidth and improved performance. It offers peak data transfer rate of up to 21 Gb/s bandwidth. The advantages of DDR3 are its higher bandwidth and its increase in performance at a lower power than DDR2.

Graphics

The integrated Intel HD graphics for graphics intensive applications delivers exceptional 3D, 2D and video capabilities. It supports VGA and DVI interfaces.

DVI

DVI (Digital Visual Interface) is a form of video interface technology made to maximize the quality of flat panel LCD monitors and modern video graphics cards. Data is transmitted using the TMDS (Transition Minimized Differential Signaling) protocol, providing a digital signal from the PC’s graphics subsystem to the display.

PCI Express

PCI Express is a high bandwidth I/O infrastructure that possesses the ability to scale speeds by forming multiple lanes. The x4 PCI Express lane supports transfer rate of 1 Gigabyte per second. The PCI Express architecture also provides a high performance graphics infrastructure by enhancing the capability of a x16 PCI Express lane to provide 8 Gigabytes per second transfer rate.

Intel Active Management Technology (AMT)

Intel Active Management Technology (Intel® AMT) allows remote access and management of networked systems even while PCs are powered off, remotely repair systems after OS failures and has the capability to remotely update all systems with the latest security software.

Audio

The Realtek ALC262 audio codec provides 2-channel High Definition audio output.

Serial ATA

Serial ATA is a storage interface that is compliant with SATA 1.0a specification. SATA 3.0 supports speed up to 6Gb/s while SATA 2.0 supports speed up to 3Gb/s. This improves hard drive performance faster than the standard parallel ATA whose data transfer rate is 100MB/s. The board supports RAID 0/1/5/10.

Gigabit LAN

The Intel W82579LM PHY and Realtek RTL8111DL PCI Express Gigabit controllers support up to 1Gbps data transmission.

USB

The system board supports USB 2.0 and USB 1.1 ports. USB 1.1 supports 12Mb/second bandwidth while USB 2.0 supports 480Mb/second bandwidth providing a marked improvement in device transfer speeds between your computer and a wide range of simultaneously accessible external Plug and Play peripherals.

Wake-On-LAN

This feature allows the network to remotely wake up a Soft Power Down (Soft-Off) PC. It is supported via the onboard LAN port or via a PCI LAN card that uses the PCI PME (Power Management Event) signal. However, if your system is in the Suspend mode, you can power-on the system only through an IRQ or DMA interrupt.

**Important:**

The 5V_standby power source of your power supply must support $\geq 720\text{mA}$.

Wake-On-PS/2

This function allows you to use the PS/2 keyboard or PS/2 mouse to power-on the system.

**Important:**

The 5V_standby power source of your power supply must support $\geq 720\text{mA}$.

Wake-On-USB

This function allows you to use a USB keyboard or USB mouse to wake up a system from the S3 (STR - Suspend To RAM) state.

**Important:**

If you are using the Wake-On-USB Keyboard/Mouse function for 2 USB ports, the 5V_standby power source of your power supply must support $\geq 1.5\text{A}$. For 3 or more USB ports, the 5V_standby power source of your power supply must support $\geq 2\text{A}$.

RTC Timer

The RTC installed on the system board allows your system to automatically power-on on the set date and time.

ACPI STR

The system board is designed to meet the ACPI (Advanced Configuration and Power Interface) specification. ACPI has energy saving features that enables PCs to implement Power Management and Plug-and-Play with operating systems that support OS Direct Power Management. ACPI when enabled in the Power Management Setup will allow you to use the Suspend to RAM function.

With the Suspend to RAM function enabled, you can power-off the system at once by pressing the power button or selecting "Standby" when you shut down Windows® without having to go through the sometimes tiresome process of closing files, applications and operating system. This is because the system is capable of storing all programs and data files during the entire operating session into RAM (Random Access Memory) when it powers-off. The operating session will resume exactly where you left off the next time you power-on the system.

**Important:**

The 5V_standby power source of your power supply must support $\geq 720\text{mA}$.

Power Failure Recovery

When power returns after an AC power failure, you may choose to either power-on the system manually or let the system power-on automatically.

Chapter 2 - Hardware Installation

System Board Layout

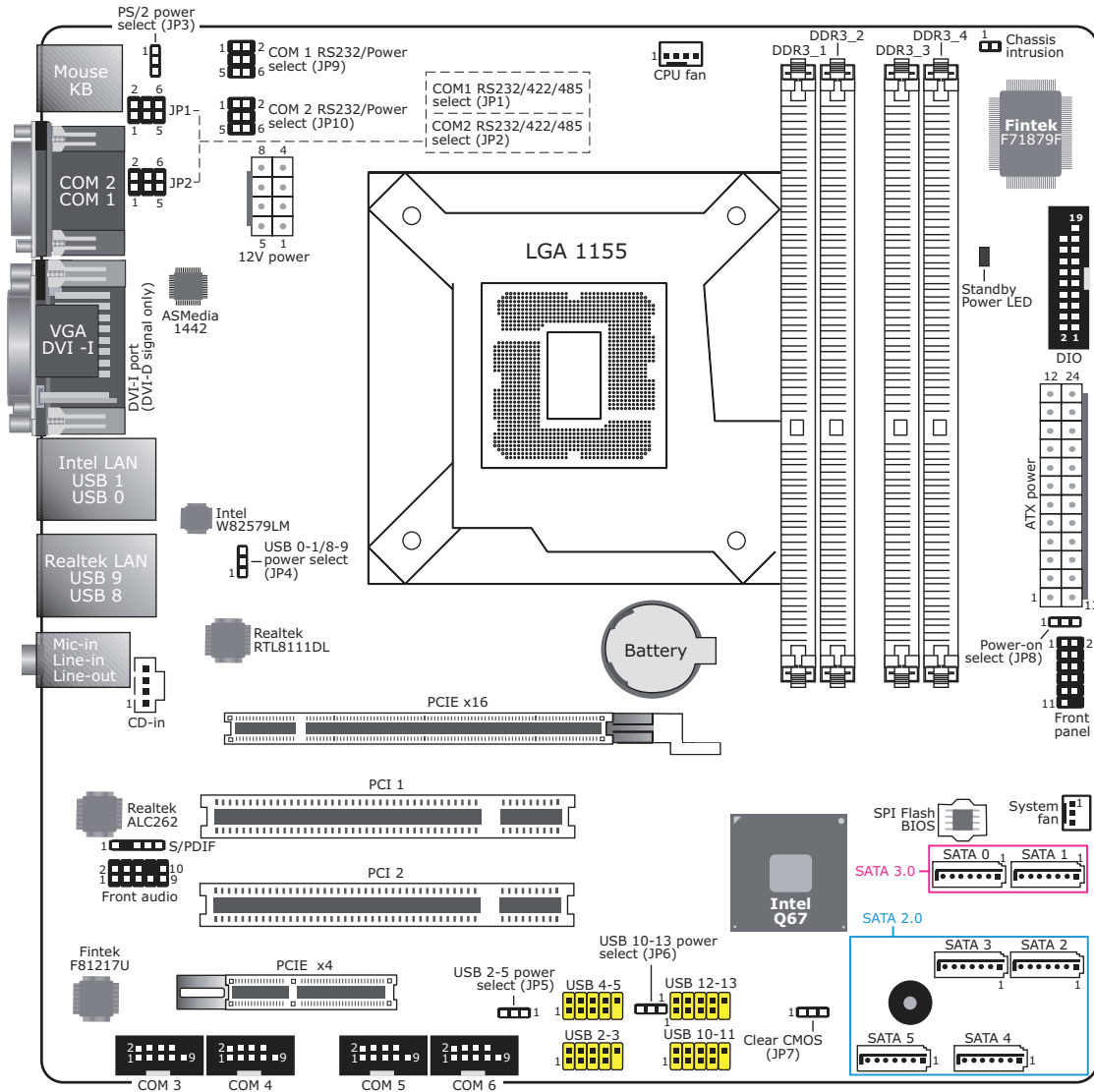

**Important:**

Electrostatic discharge (ESD) can damage your system board, processor, disk drives, add-in boards, and other components. Perform the upgrade instruction procedures described at an ESD workstation only. If such a station is not available, you can provide some ESD protection by wearing an antistatic wrist strap and attaching it to a metal part of the system chassis. If a wrist strap is unavailable, establish and maintain contact with the system chassis throughout any procedures requiring ESD protection.

System Memory

**Important:**

When the Standby Power LED lit red, it indicates that there is power on the system board. Power-off the PC then unplug the power cord prior to installing any devices. Failure to do so will cause severe damage to the motherboard and components.

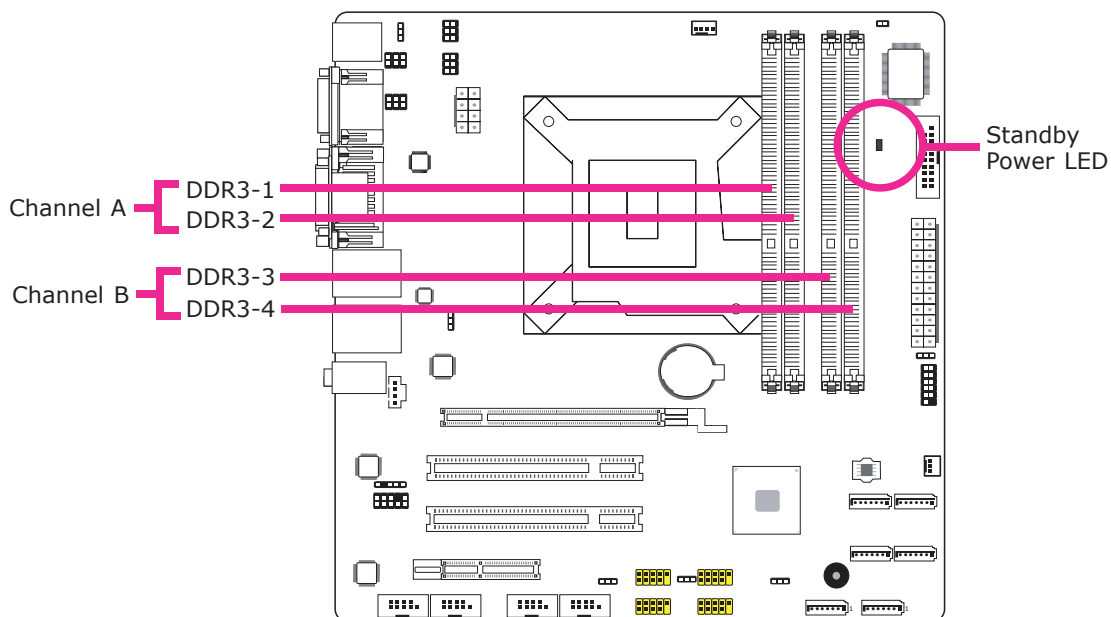

Features

- The four DIMM sockets are divided into 2 channels:
 - Channel A - DDR3_1 and DDR3_2
 - Channel B - DDR3_3 and DDR3_4
- Dual channel memory interface
- Maximum of 32GB system memory

The system board supports the following memory interface.

Single Channel (SC)

Data will be accessed in chunks of 64 bits (8B) from the memory channels.

Dual Channel (DC)

Data will be accessed in chunks of 128 bits from the memory channels. Dual channel provides better system performance because it doubles the data transfer rate.

Single Channel	DIMMs are on the same channel. DIMMs in a channel can be identical or completely different. However, we highly recommend using identical DIMMs. Not all slots need to be populated.
Dual Channel	DIMMs of the same memory configuration are on different channels.



Important:

1. You can populate either Channel A or Channel B first.
2. When installing a DIMM in Channel A or Channel B, always populate the socket that is farthest the CPU. In this case, it will mean populating DDR3-2 and/or DDR3-4 first.
3. If you intend to use dual channel, the same rule applies - always the socket farthest the CPU. Populate DDR3-2 and/or DDR3-4 first; not DDR3-2 and DDR3-3 and not DDR3-1 and DDR3-4.

Installing the DIM Module

**Note:**

The system board used in the following illustrations may not resemble the actual board. These illustrations are for reference only.

1. Make sure the PC and all other peripheral devices connected to it has been powered down.
2. Disconnect all power cords and cables.
3. Locate the DIMM socket on the system board.
4. Push the "ejector tabs" which are at the ends of the socket to the side.

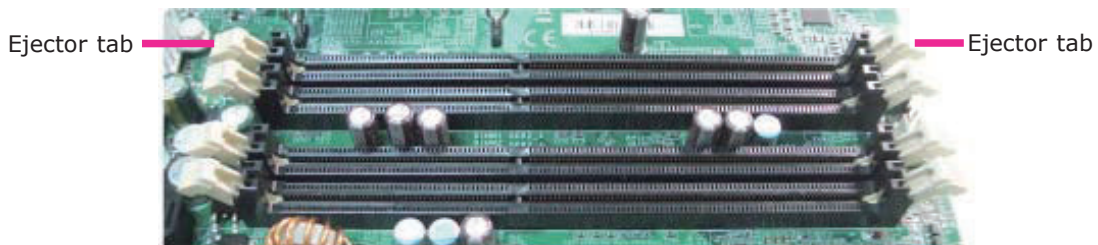

5. Note how the module is keyed to the socket.

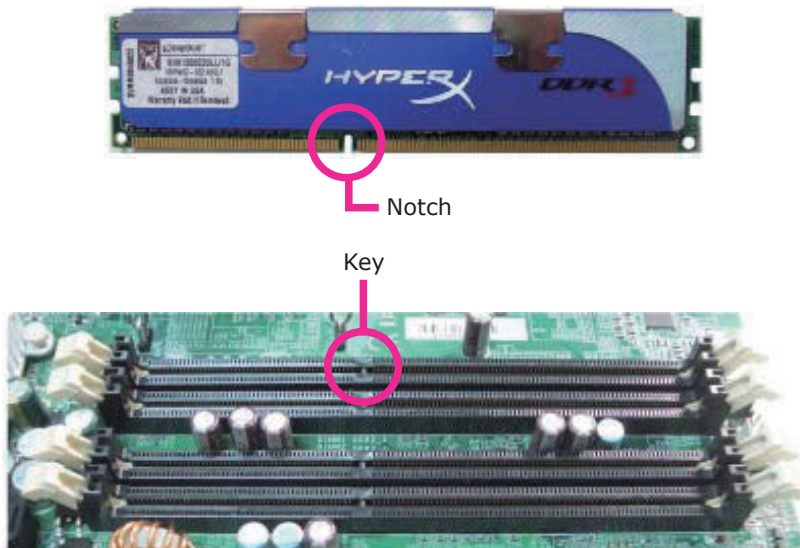

6. Grasping the module by its edges, position the module above the socket with the “notch” in the module aligned with the “key” on the socket. The keying mechanism ensures the module can be plugged into the socket in only one way.

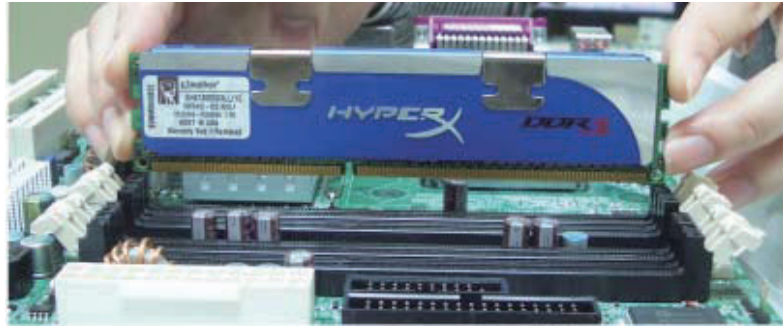

7. Seat the module vertically, pressing it down firmly until it is completely seated in the socket.

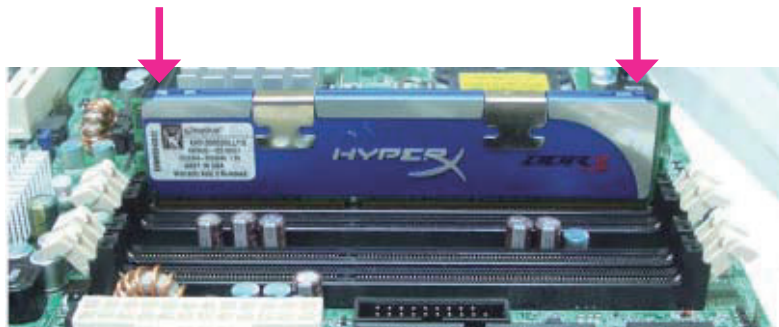

8. The ejector tabs at the ends of the socket will automatically snap into the locked position to hold the module in place.



CPU

The system board is equipped with a surface mount LGA 1155 socket. This socket is exclusively designed for installing a LGA 1155 packaged Intel CPU.

**Important:**

1. Before you proceed, make sure (1) the LGA 1155 socket comes with a protective cap, (2) the cap is not damaged and (3) the socket's contact pins are not bent. If the cap is missing or the cap and/or contact pins are damaged, contact your dealer immediately.
2. Make sure to keep the protective cap. RMA requests will be accepted and processed only if the LGA 1155 socket comes with the protective cap.

**Note:**

The system board used in the following illustrations may not resemble the actual board. These illustrations are for reference only.

Installing the CPU

1. Make sure the PC and all other peripheral devices connected to it has been powered down.
2. Disconnect all power cords and cables.
3. Locate the LGA 1155 CPU socket on the system board.

Important:

The CPU socket must not come in contact with anything other than the CPU. Avoid unnecessary exposure. Remove the protective cap only when you are about to install the CPU.

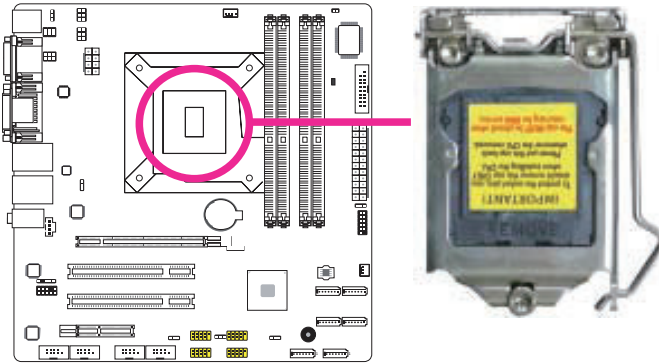

4. Unlock the socket by pushing the load lever down, moving it sideways until it is released from the retention tab; then lift the load lever up.



- Lifting the load lever will at the same time lift the load plate.

Lift the load lever up to the angle shown on the photo.

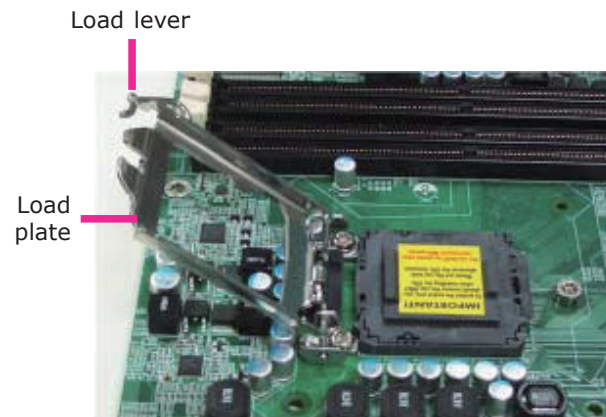

- Remove the protective cap from the CPU socket. The cap is used to protect the CPU socket against dust and harmful particles. Remove the protective cap only when you are about to install the CPU.

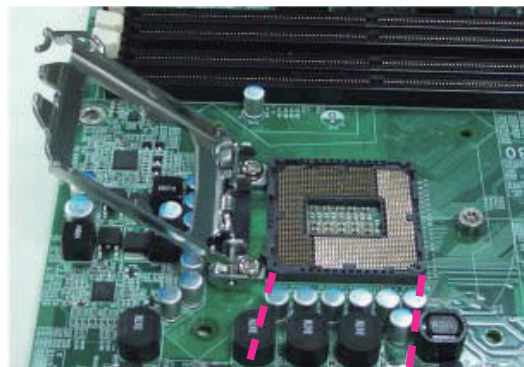

Protective cap

7. Insert the CPU into the socket. The gold triangular mark on the CPU must align with the corner of the CPU socket shown on the photo.

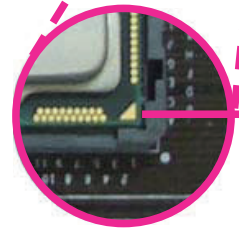
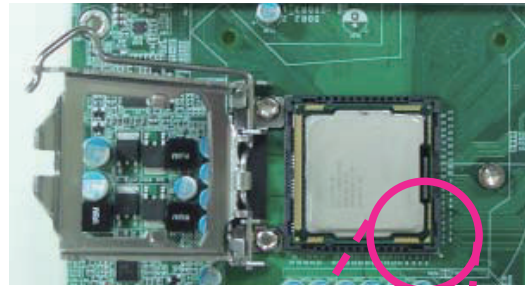

Gold triangular mark

The CPU's notch will at the same time fit into the socket's alignment key.

Important:

The CPU will fit in only one orientation and can easily be inserted without exerting any force.

Alignment key

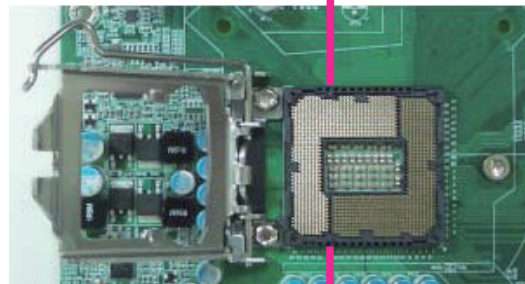

Alignment key

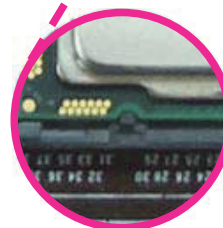
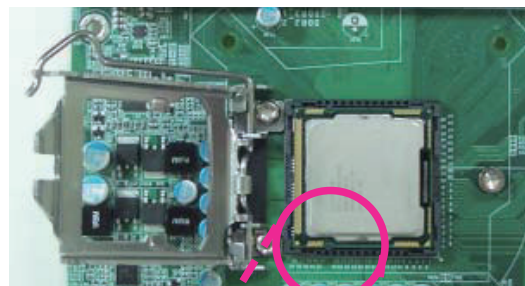

8. Close the load plate then push the load lever down.

While closing the load plate, make sure the front edge of the load plate slides under the retention knob.



Retention knob

9. Hook the load lever under the retention tab.

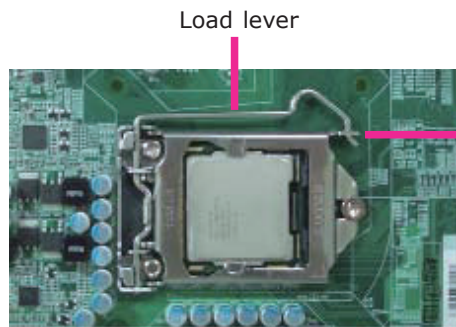

Load lever

Retention tab

Installing the Fan and Heat Sink

The CPU must be kept cool by using a CPU fan with heat sink. Without sufficient air circulation across the CPU and heat sink, the CPU will overheat damaging both the CPU and system board.

**Note:**

A boxed Intel® processor already includes the CPU fan and heat sink assembly. If your CPU was purchased separately, make sure to only use Intel®-certified fan and heat sink.

1. Before you install the fan / heat sink, you must apply a thermal paste onto the top of the CPU. The thermal paste is usually supplied when you purchase the fan / heat sink assembly. Do not spread the paste all over the surface. When you later place the heat sink on top of the CPU, the compound will disperse evenly.

Some heat sinks come with a patch of pre-applied thermal paste. Do not apply thermal paste if the fan / heat sink already has a patch of thermal paste on its underside. Peel the strip that covers the paste before you place the fan / heat sink on top of the CPU.

2. Place the heat sink on top of the CPU. The 4 push-pins around the heat sink, which are used to secure the heat sink onto the system board, must match the 4 mounting holes around the socket.

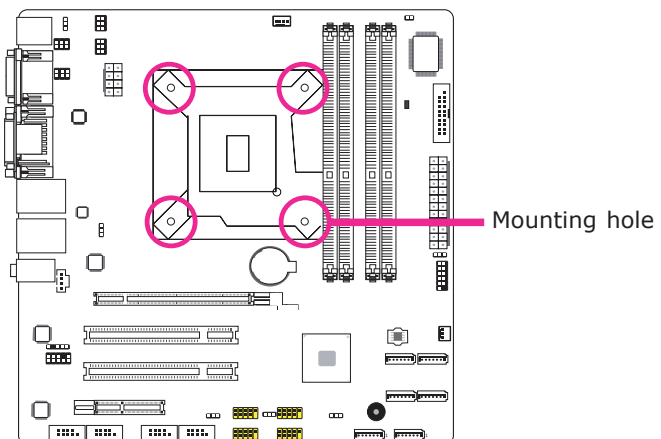

3. Orient the heat sink such that the CPU fan's cable is nearest the CPU fan connector.

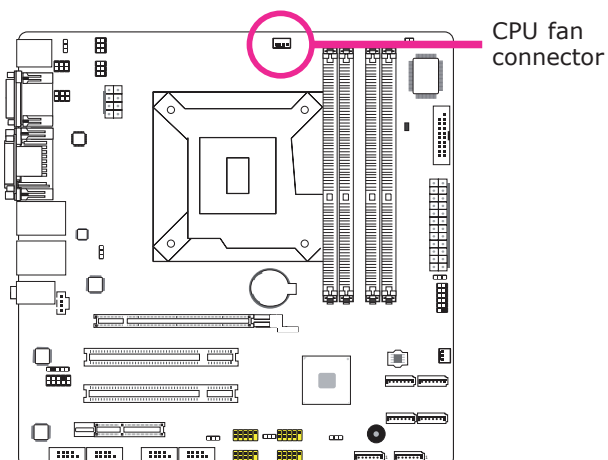

4. Rotate each push-pin according to the direction of the arrow shown on top of the pin.

Push down two pushpins that are diagonally across the heat sink. Perform the same procedure for the other two push-pins.

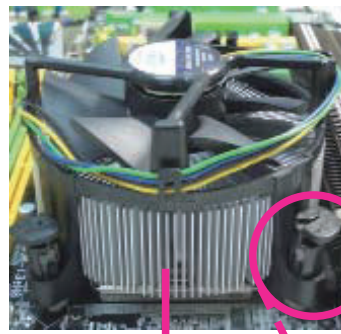

Heat sink



"Locked" position of push-pin



"Unlocked" position of push-pin

5. Connect the CPU fan's cable to the CPU fan connector on the system board.

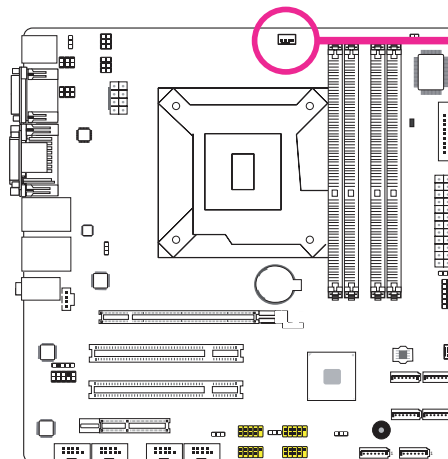

CPU fan connector

Jumper Settings

Clear CMOS Data

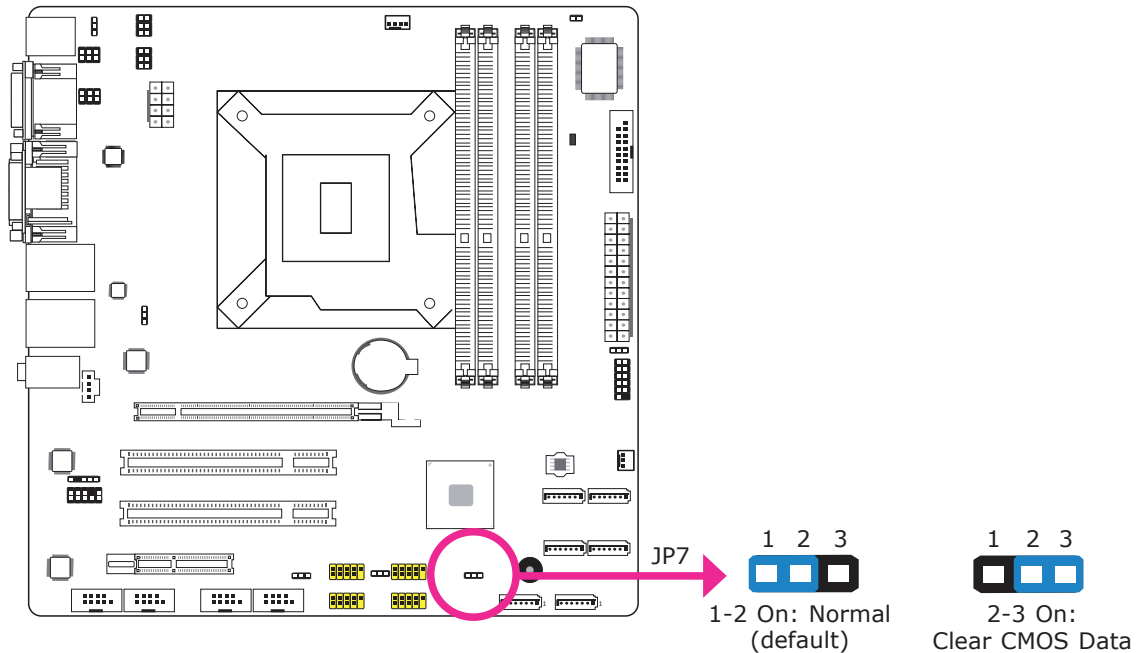

If you encounter the following,

- CMOS data becomes corrupted.
- You forgot the supervisor or user password.

you can reconfigure the system with the default values stored in the ROM BIOS.

To load the default values stored in the ROM BIOS, please follow the steps below.

- Power-off the system and unplug the power cord.
- Set JP7 pins 2 and 3 to On. Wait for a few seconds and set JP7 back to its default setting, pins 1 and 2 On.
- Now plug the power cord and power-on the system.

PS/2 Power Select

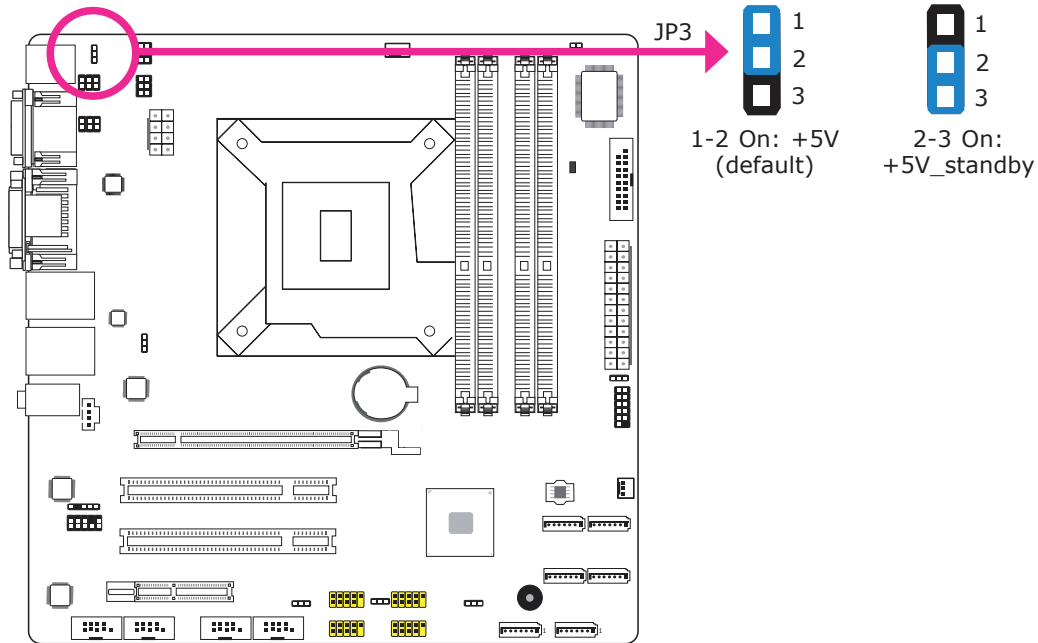

JP3 is used to select the power of the PS/2 keyboard and PS/2 mouse ports. Selecting +5V_standby will allow you to use the PS/2 keyboard or PS/2 mouse to wake up the system.

**Important:**

The +5VSB power source of your power supply must support $\geq 720\text{mA}$.

USB Power Select

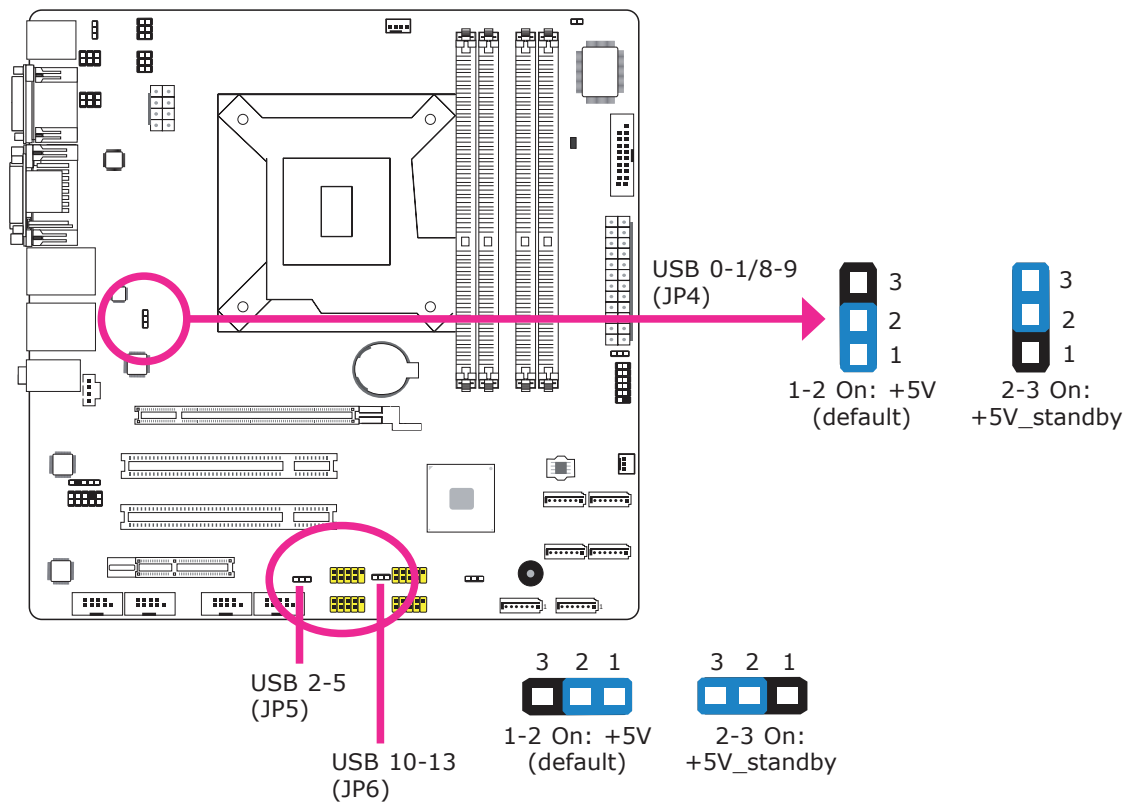

These jumpers are used to select the power of the USB ports. Selecting +5V_standby will allow you to use a USB device to wake up the system.



Important:

If you are using the Wake-On-USB Keyboard/Mouse function for 2 USB ports, the +5V_standby power source of your power supply must support $\geq 1.5A$. For 3 or more USB ports, the +5V_standby power source of your power supply must support $\geq 2A$.

Power-on Select

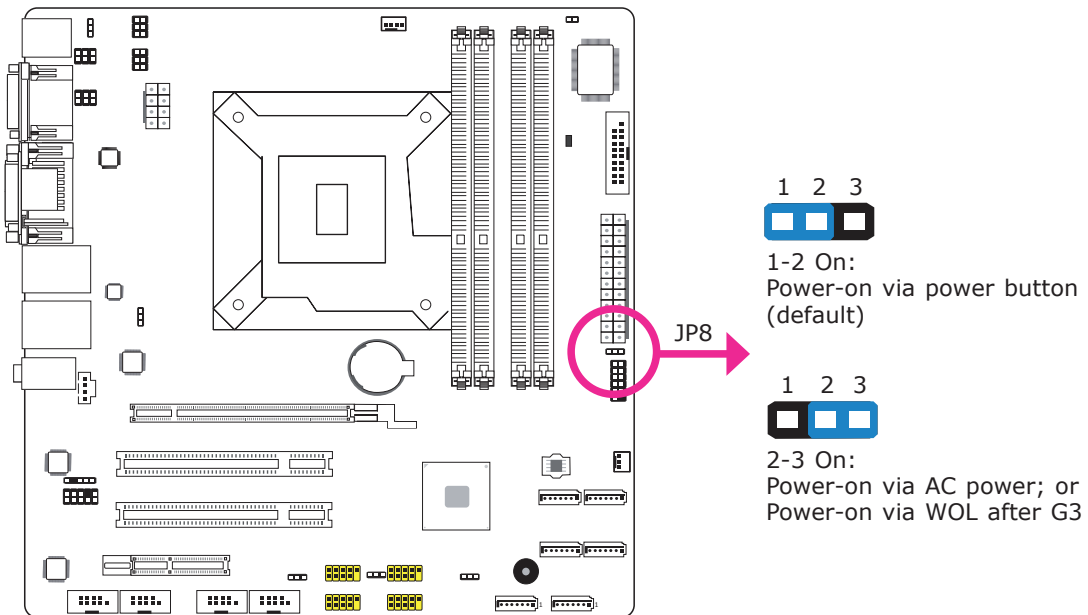

To power-on via WOL after G3:

1. Set JP8 pins 2 and 3 to On.
2. Set the "After G3" field to **Power Off/WOL**.
3. Set the "GbE Wake Up From S5" to **Enabled**.

The BIOS fields are in the "South Bridge Configuration" submenu (Chipset menu) of the AMI BIOS utility.

To power-on via AC Power:

1. Set JP8 pins 2 and 3 to On.
2. Set the "After G3" field to **Power On**.

COM1/COM2 RS232/RS422/RS485 Select

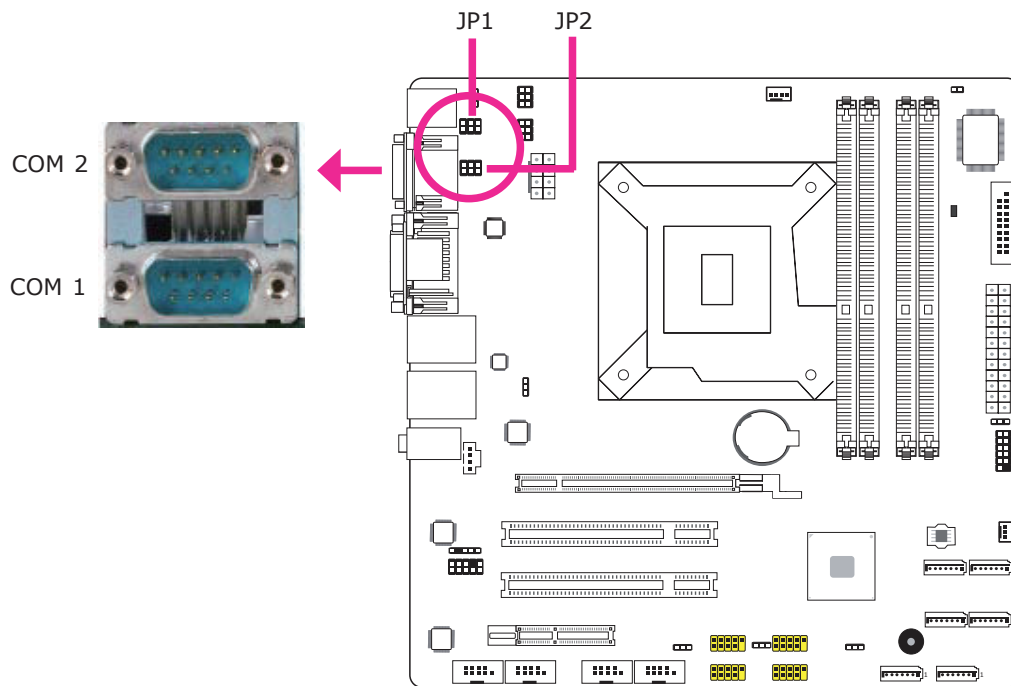

JP1 (for COM1) and JP2 (for COM2) are used to configure the COM ports to RS232, RS422 (Full Duplex) or RS485.

The pin function of the COM ports will vary according to the jumper's setting.

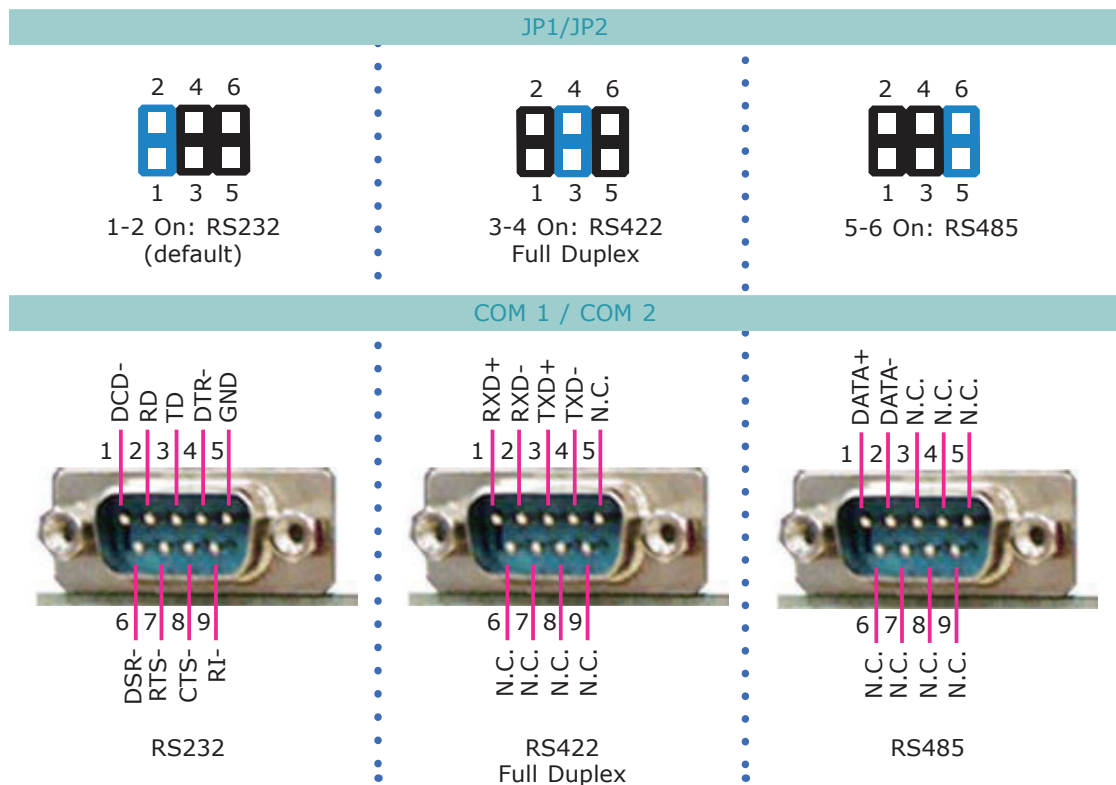

COM1/COM2 RS232/Power Select

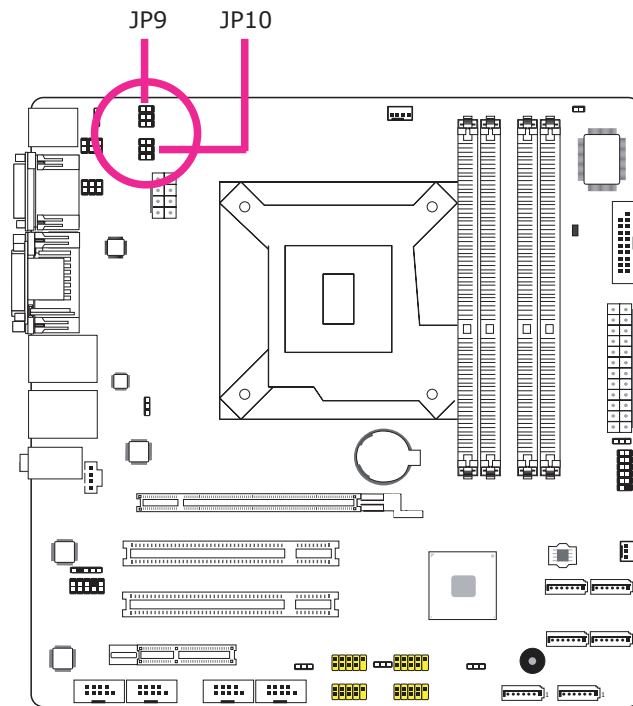

- | | | | |
|---|--|---|-------------------------|
| 1 | | 2 | 1-3 (RI), 2-4 (DCD) On: |
| 3 | | 4 | RS232 (default) |
| 5 | | 6 | |

- | | | | |
|---|--|---|---------------------------|
| 1 | | 2 | 3-5 (+5V), 4-6 (+12V) On: |
| 3 | | 4 | RS232 with power |
| 5 | | 6 | |

Rear Panel I/O Ports

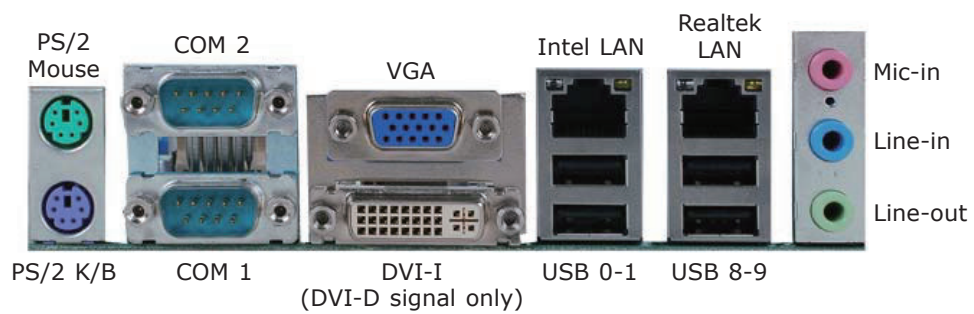

The rear panel I/O ports consist of the following:

- PS/2 mouse port
- PS/2 keyboard port
- 2 COM ports
- VGA port
- DVI-I port (DVI-D signal only)
- Intel LAN port
- Realtek LAN port
- 4 USB ports
- Mic-in jack
- Line-in jack
- Line-out jack

PS/2 Mouse and PS/2 Keyboard Ports

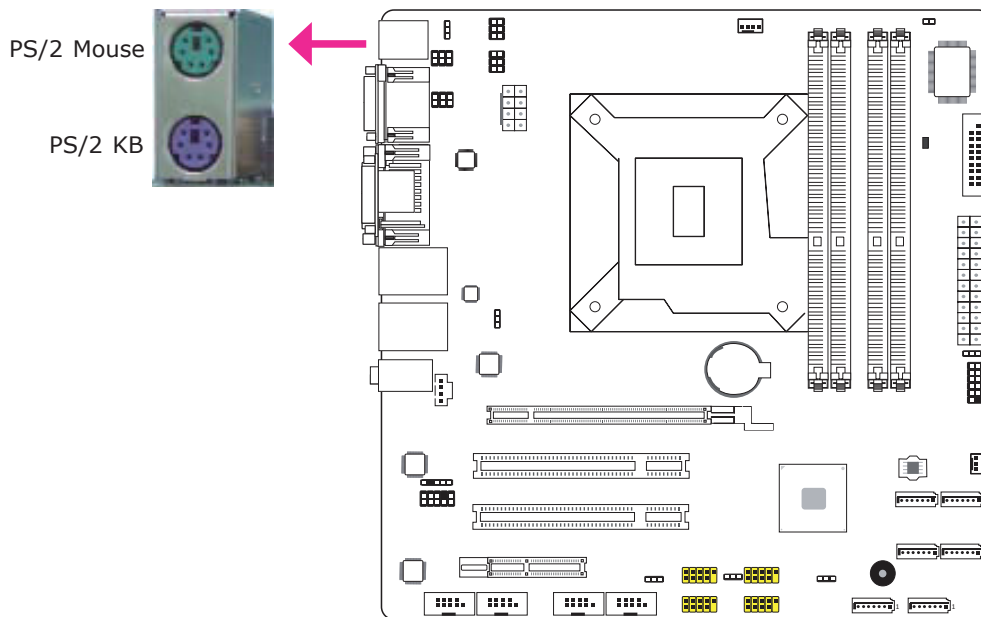

These ports are used to connect a PS/2 mouse and a PS/2 keyboard. The PS/2 mouse port uses IRQ12.

Wake-On-PS/2 Keyboard/Mouse

The Wake-On-PS/2 Keyboard/Mouse function allows you to use the PS/2 keyboard or PS/2 mouse to power-on the system. To use this function:

- **Jumper Setting**

JP3 must be set to "2-3 On: +5V_standby". Refer to "PS/2 Power Select" in this chapter for more information.

- **BIOS Setting**

Configure the PS/2 keyboard/mouse wake up function in the Advanced menu ("ACPI Power Management Configuration" submenu) of the BIOS. Refer to chapter 3 for more information.



Important:

The +5V_standby power source of your power supply must support $\geq 720\text{mA}$.

COM (Serial) Ports

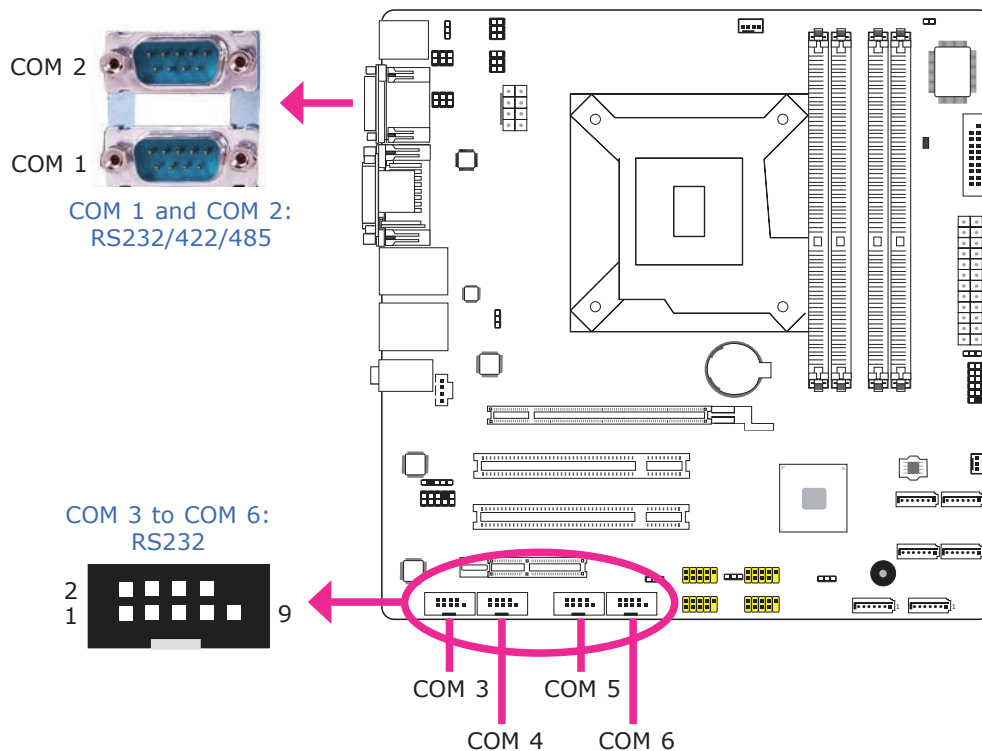

COM 3 to COM 6 are fixed at RS232.

The pin function of COM 1 and COM 2 ports will vary according to JP1/JP2's setting. Refer to "COM1/COM2 RS232/RS422/RS485 Select" in this chapter for more information.

The serial ports are asynchronous communication ports with 16C550A-compatible UARTs that can be used with modems, serial printers, remote display terminals, and other serial devices.

Connecting External Serial Ports

Your COM port may come mounted on a card-edge bracket. Install the card-edge bracket to an available slot at the rear of the system chassis then insert the serial port cable to the COM connector. Make sure the colored stripe on the ribbon cable is aligned with pin 1 of the COM connector.

BIOS Setting

Configure the serial ports in the Advanced menu ("Super IO Configuration" sub-menu) of the BIOS. Refer to chapter 3 for more information.

VGA Port

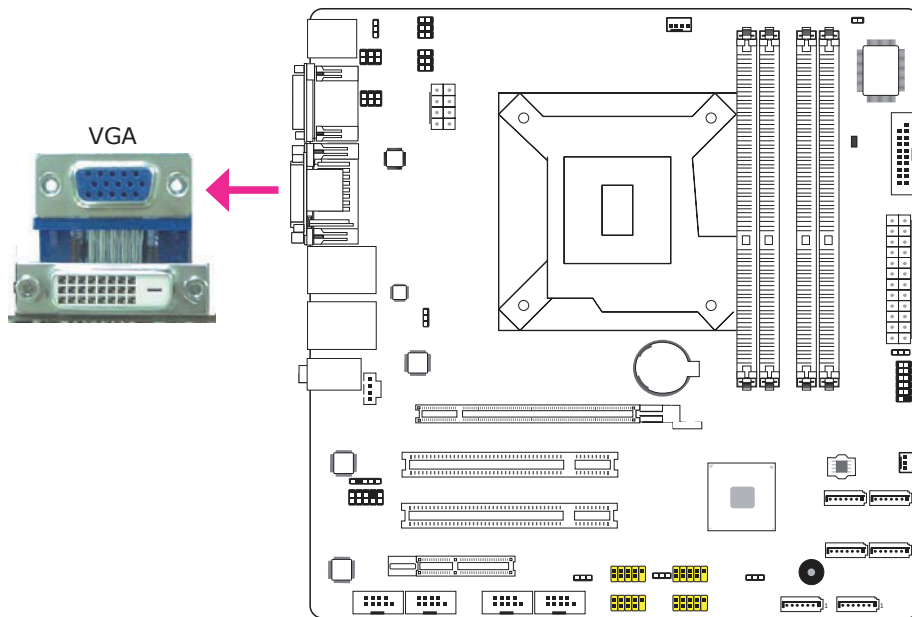

The VGA port is used for connecting a VGA monitor. Connect the monitor's 15-pin D-shell cable connector to the VGA port. After you plug the monitor's cable connector into the VGA port, gently tighten the cable screws to hold the connector in place.

BIOS Setting

Configure VGA in the Chipset menu ("North Bridge Configuration" submenu) of the BIOS. Refer to chapter 3 for more information.

Driver Installation

Install the graphics driver. Refer to chapter 4 for more information.

DVI-I Port

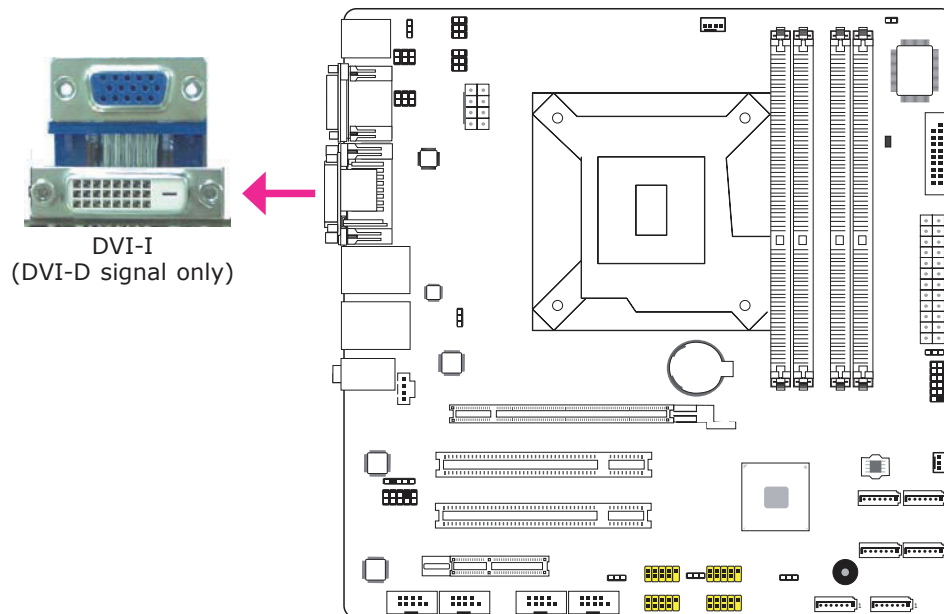

The DVI-I port is used to connect an LCD monitor. This port supports DVI-D signal only.

Connect the display device's cable connector to the DVI-I port. After you plug the cable connector into the port, gently tighten the cable screws to hold the connector in place.

BIOS Setting

Configure the display device in the Chipset menu ("North Bridge Configuration" submenu) of the BIOS. Refer to chapter 3 for more information.

RJ45 LAN Ports

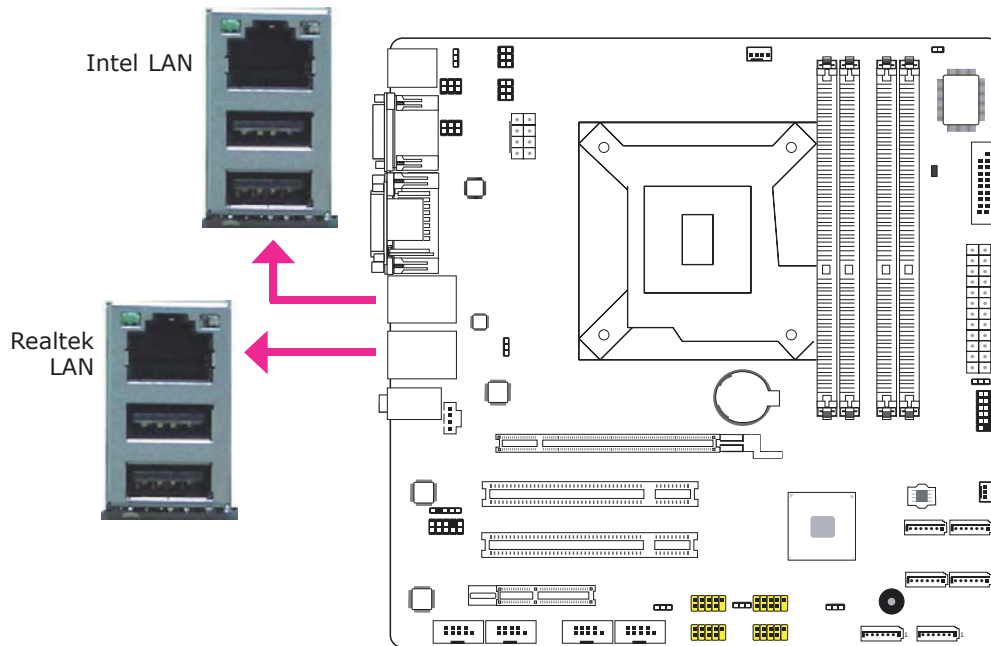

Features

- Intel 82579LM with iAMT7.0 Gigabit Ethernet Phy
- Realtek RTL8111DL PCI Express Gigabit Ethernet controller

The LAN ports allow the system board to connect to a local area network by means of a network hub.

BIOS Setting

Configure the onboard LAN in the Chipset menu ("South Bridge Configuration" submenu) of the BIOS. Refer to chapter 3 for more information.

Driver Installation

Install the LAN drivers. Refer to chapter 4 for more information.

USB Ports

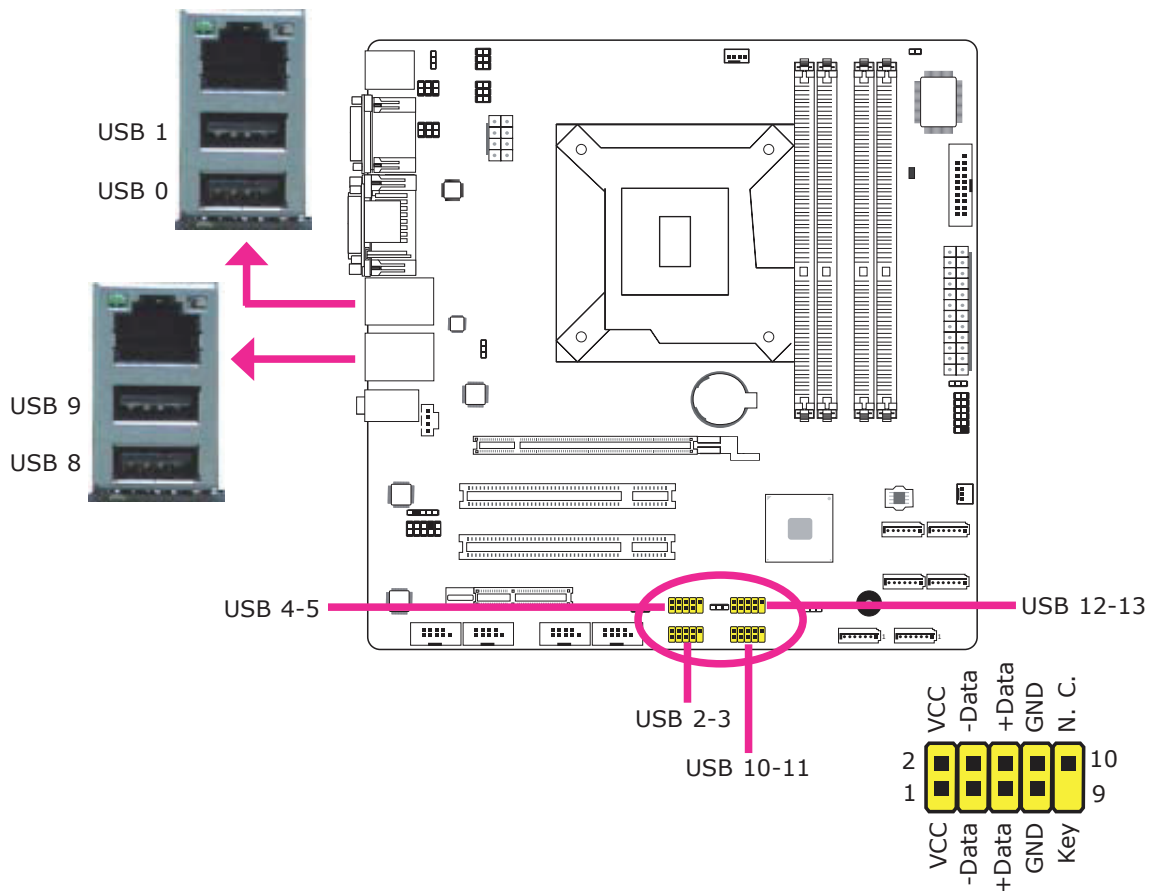

USB allows data exchange between your computer and a wide range of simultaneously accessible external Plug and Play peripherals.

The system board is equipped with four onboard USB 2.0/1.1 ports. The four 10-pin connectors allow you to connect 8 additional USB 2.0/1.1 ports. The additional USB ports may be mounted on a card-edge bracket. Install the card-edge bracket to an available slot at the rear of the system chassis and then insert the USB port cables to a connector.

BIOS Setting

Configure the onboard USB in the Advanced menu ("USB Configuration" sub-menu) of the BIOS. Refer to chapter 3 for more information.

Driver Installation

You may need to install the proper drivers in your operating system to use the USB device. Refer to your operating system's manual or documentation for more information.

Wake-On-USB Keyboard/Mouse

The Wake-On-USB Keyboard/Mouse function allows you to use a USB keyboard or USB mouse to wake up a system from the S3 (STR - Suspend To RAM) state. To use this function:

- **Jumper Setting**

JP4, JP5 and/or JP6 must be set to "2-3 On: 5V_standby". Refer to "USB Power Select" in this chapter for more information.



Important:

If you are using the Wake-On-USB Keyboard/Mouse function for 2 USB ports, the 5V_standby power source of your power supply must support $\geq 1.5A$. For 3 or more USB ports, the 5V_standby power source of your power supply must support $\geq 2A$.

Audio

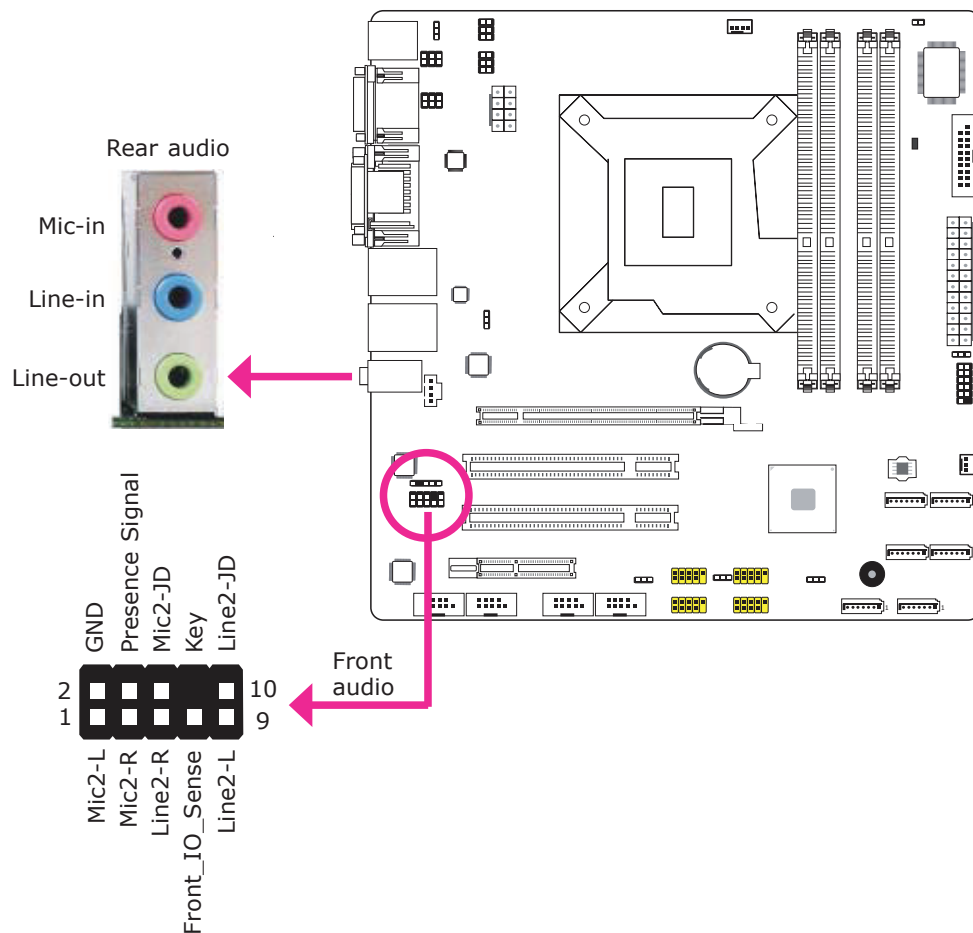

Rear Audio

The system board is equipped with 3 audio jacks. A jack is a one-hole connecting interface for inserting a plug.

- **Mic-in Jack (Pink)**
This jack is used to connect an external microphone.
- **Line-in Jack (Light Blue)**
This jack is used to connect any audio devices such as Hi-fi set, CD player, tape player, AM/FM radio tuner, synthesizer, etc.
- **Line-out Jack (Lime)**
This jack is used to connect a headphone or external speakers.

Front Audio

The front audio connector allows you to connect to the second line-out and mic-in jacks that are at the front panel of your system.

BIOS Setting

Configure the onboard audio in the Chipset menu (“South Bridge” submenu) of the BIOS. Refer to chapter 3 for more information.

Driver Installation

Install the audio driver. Refer to chapter 4 for more information.

I/O Connectors

CD-in Internal Audio Connector

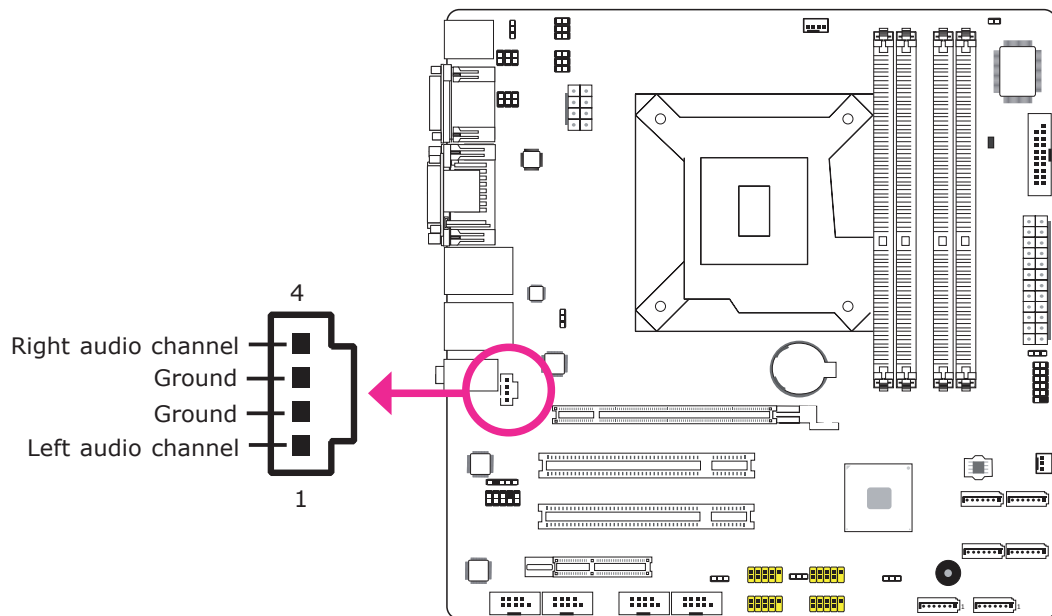

The CD-in connector is used to receive audio from a CD-ROM drive, TV tuner or MPEG card.

S/PDIF Connector

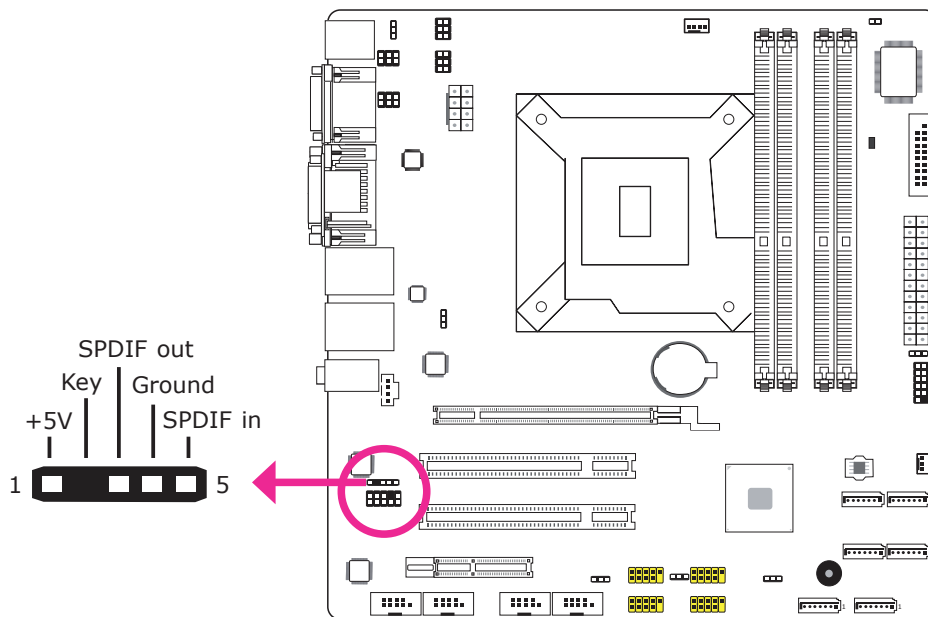

The S/PDIF connector is used to connect an external S/PDIF port. Your S/PDIF port may be mounted on a card-edge bracket. Install the card-edge bracket to an available slot at the rear of the system chassis then connect the audio cable to the S/PDIF connector. Make sure pin 1 of the audio cable is aligned with pin 1 of the S/PDIF connector.

Digital I/O Connectors

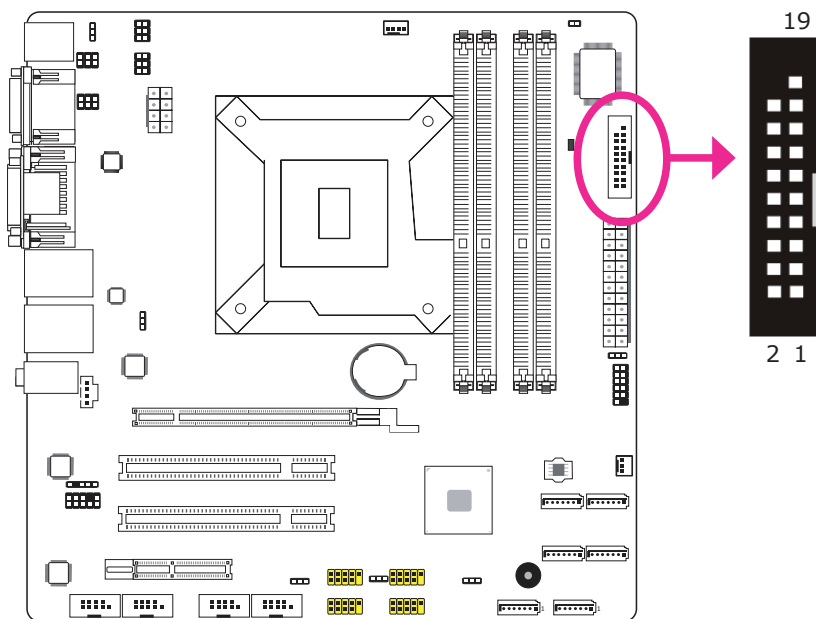

The 8-bit Digital I/O connector provides powering-on function to external devices that are connected to these connectors.

Pin	Pin Assignment	Pin	Pin Assignment
1	GND	2	+12V
3	DIO7	4	+12V
5	DIO6	6	GND
7	DIO5	8	VCC
9	DIO4	10	VCC
11	DIO3	12	GND
13	DIO2	14	V_5P0_STBY
15	DIO1	16	V_5P0_STBY
17	DIO0	18	GND
19	GND		

SATA (Serial ATA) Connectors

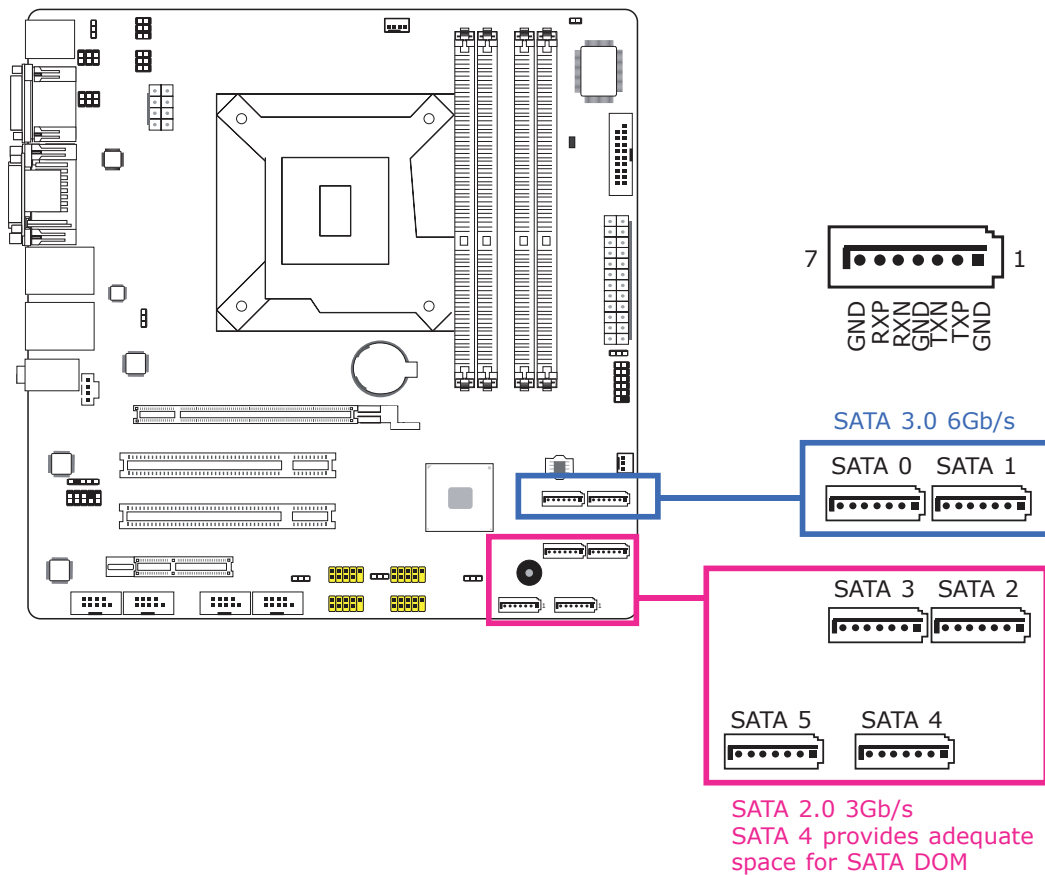

Features

- SATA 0 and SATA 1 support data transfer rate up to 6Gb/s
- SATA 2 to SATA 5 support data transfer rate up to 3Gb/s
SATA 4 provides adequate space for SATA DOM
- Integrated Advanced Host Controller Interface (AHCI) controller
- Supports RAID 0, RAID 1, RAID 5 and RAID 10

The Serial ATA connectors are used to connect Serial ATA devices. Connect one end of the Serial ATA cable to a SATA connector and the other end to your Serial ATA device.

BIOS Setting

Configure the Serial ATA drives in the Advanced menu ("IDE Configuration" sub-menu) of the BIOS. Refer to chapter 3 for more information.

Cooling Fan Connectors

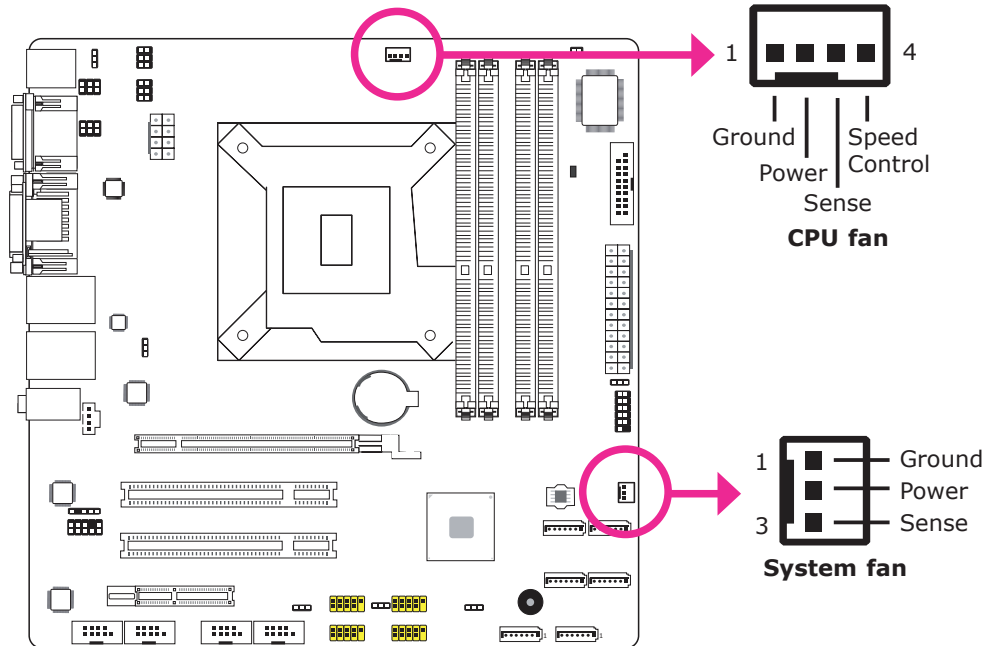

The fan connectors are used to connect cooling fans. The cooling fans will provide adequate airflow throughout the chassis to prevent overheating the CPU and system board components.

BIOS Setting

The Advanced menu ("Hardware Health Configuration" submenu) of the BIOS will display the current speed of the cooling fans. Refer to chapter 3 for more information.

Chassis Intrusion Connector

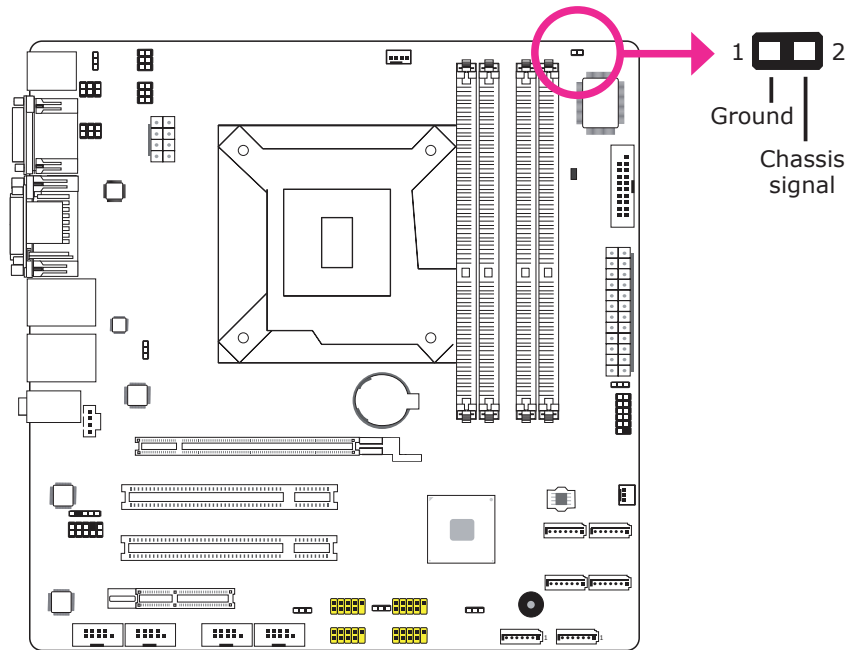

The board supports the chassis intrusion detection function. Connect the chassis intrusion sensor cable from the chassis to this connector. When the system's power is on and a chassis intrusion occurred, an alarm will sound. When the system's power is off and a chassis intrusion occurred, the alarm will sound only when the system restarts.

MyGuard Hardware Monitor

Install the "MyGuard Hardware Monitor" utility. By default, the chassis intrusion detection function is disabled. When enabled, a warning message will appear when the chassis is open. The utility can also be configured so that a beeping alarm will sound when the chassis is open. Refer to the "MyGuard Hardware Monitor" section in chapter 4 for more information.

Power Connectors

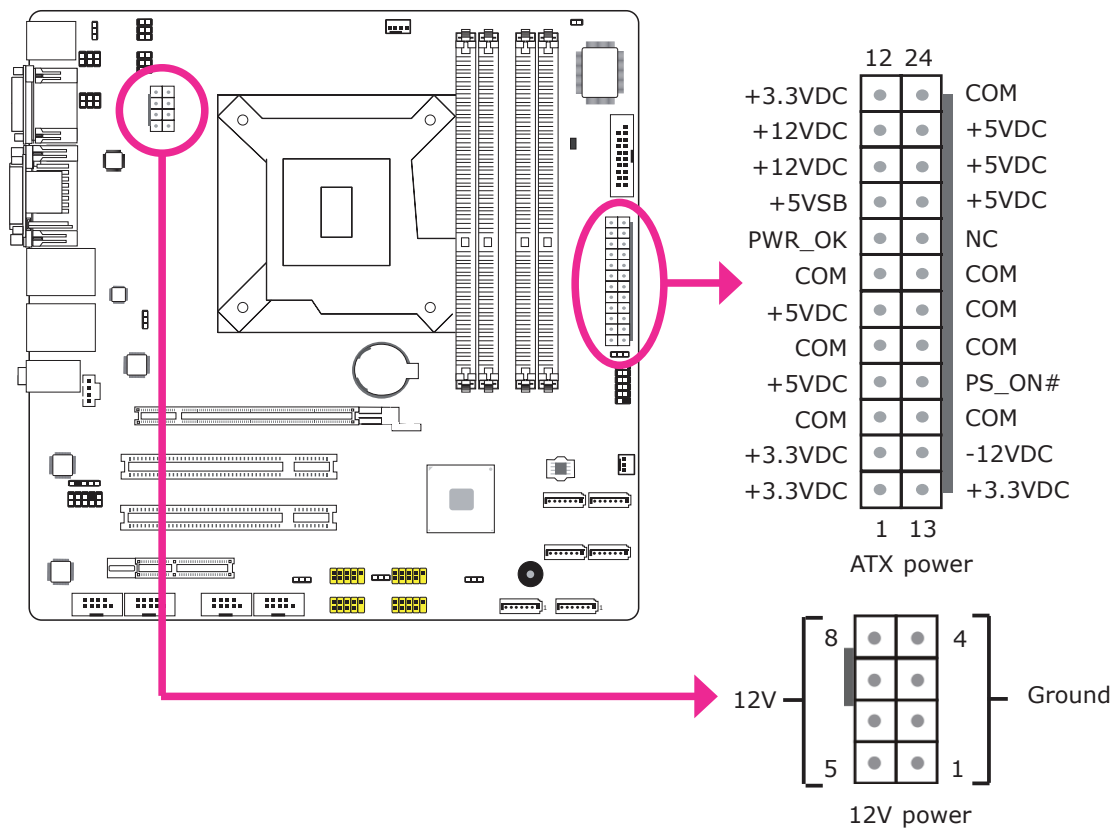

Use a power supply that complies with the ATX12V Power Supply Design Guide Version 1.1. An ATX12V power supply unit has a standard 24-pin ATX main power connector that must be inserted into the 24-pin connector. The 8-pin +12V power connector enables the delivery of more +12VDC current to the processor's Voltage Regulator Module (VRM).

The power connectors from the power supply unit are designed to fit the 24-pin and 8-pin connectors in only one orientation. Make sure to find the proper orientation before plugging the connectors.

The system board requires a minimum of 300 Watt power supply to operate. Your system configuration (CPU power, amount of memory, add-in cards, peripherals, etc.) may exceed the minimum power requirement. To ensure that adequate power is provided, we strongly recommend that you use a minimum of 400 Watt (or greater) power supply.



Important:

Insufficient power supplied to the system may result in instability or the add-in boards and peripherals not functioning properly. Calculating the system's approximate power usage is important to ensure that the power supply meets the system's consumption requirements.

Standby Power LED

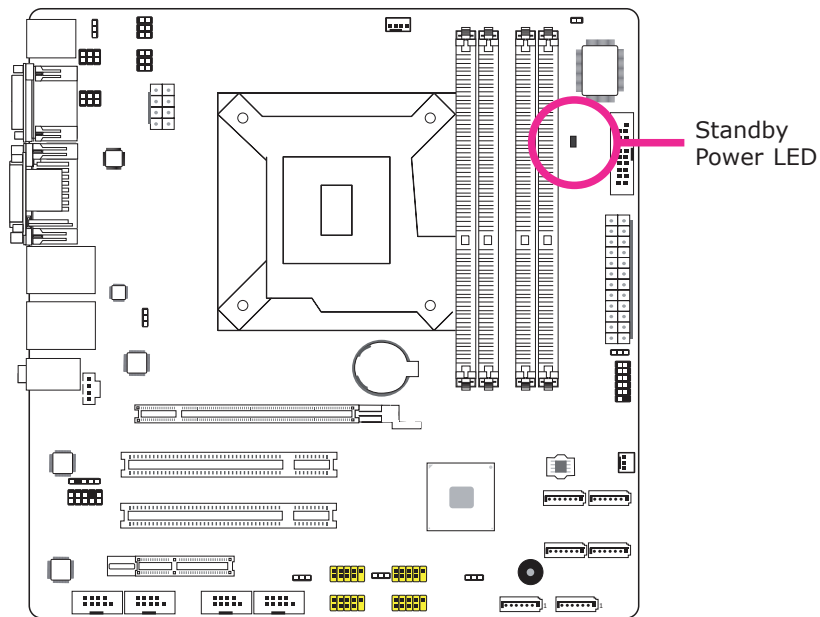

This LED will light red when the system is in the standby mode. It indicates that there is power on the system board. Power-off the PC and then unplug the power cord prior to installing any devices. Failure to do so will cause severe damage to the motherboard and components.

Front Panel Connectors

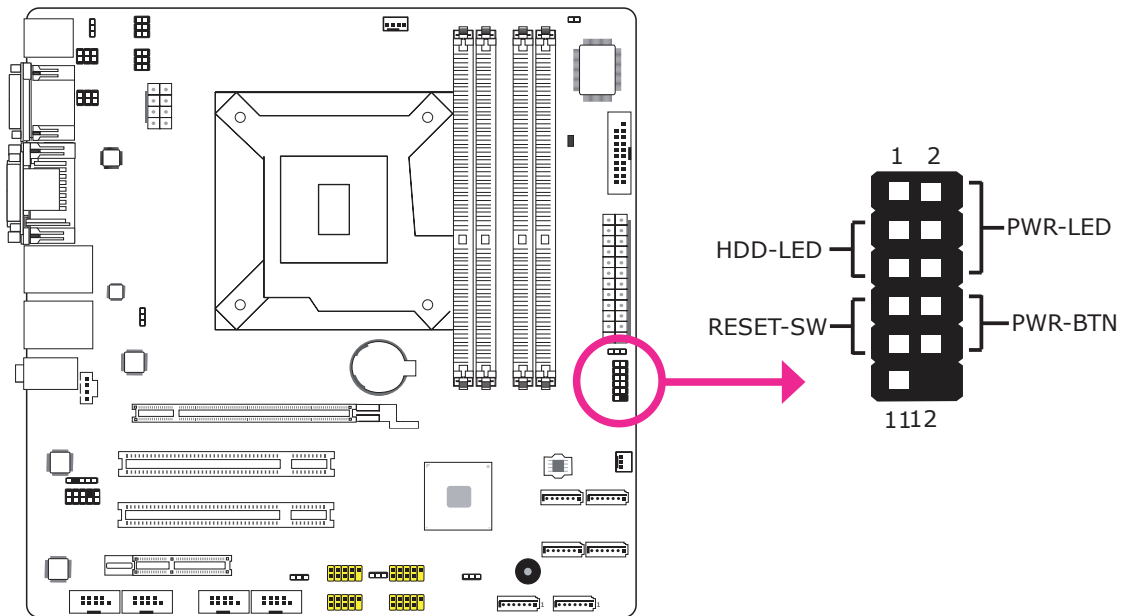

HDD-LED - HDD LED

This LED will light when the hard drive is being accessed.

RESET SW - Reset Switch

This switch allows you to reboot without having to power off the system.

PWR-BTN - Power Switch

This switch is used to power on or off the system.

PWR-LED - Power/Standby LED

When the system's power is on, this LED will light. When the system is in the S1 (POS - Power On Suspend) state, it will blink every second. When the system is in the S3 (STR - Suspend To RAM) state, it will blink every 4 seconds.

	Pin	Pin Assignment		Pin	Pin Assignment
HDD-LED	3	HDD Power	PWR-LED	2	LED Power
	5	Signal		4	LED Power
RESET SW	7	Ground		6	Signal
	9	RST Signal	PWR-BTN	8	Ground
	11	N.C.		10	Signal

Expansion Slots

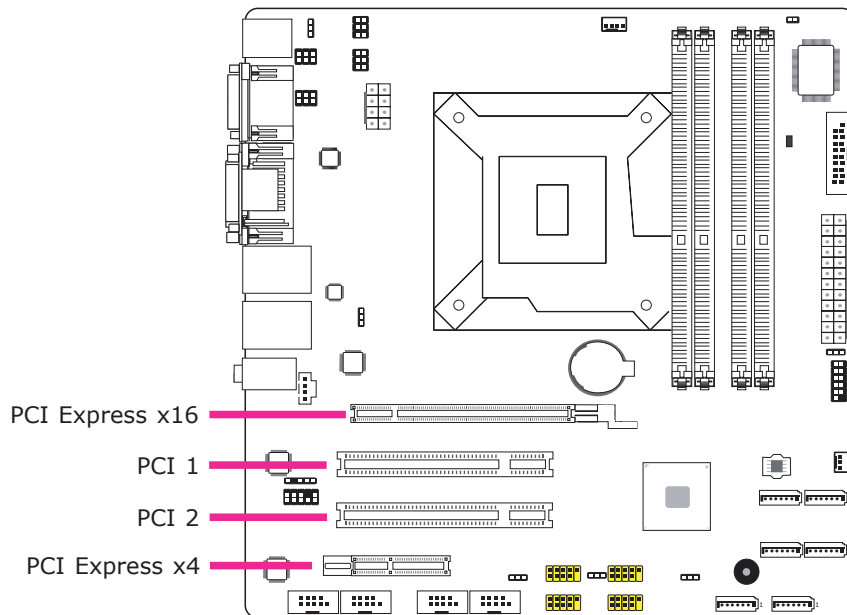

PCI Express x16 Slot

Install PCI Express x16 graphics card, that comply to the PCI Express specifications, into the PCI Express x16 slot. To install a graphics card into the x16 slot, align the graphics card above the slot then press it down firmly until it is completely seated in the slot. The retaining clip of the slot will automatically hold the graphics card in place.

PCI Express x4 Slot

Install PCI Express cards such as network cards or other cards that comply to the PCI Express specifications into the PCI Express x4 slot.

PCI Slots

The PCI slot supports expansion cards that comply with PCI specifications.

Battery

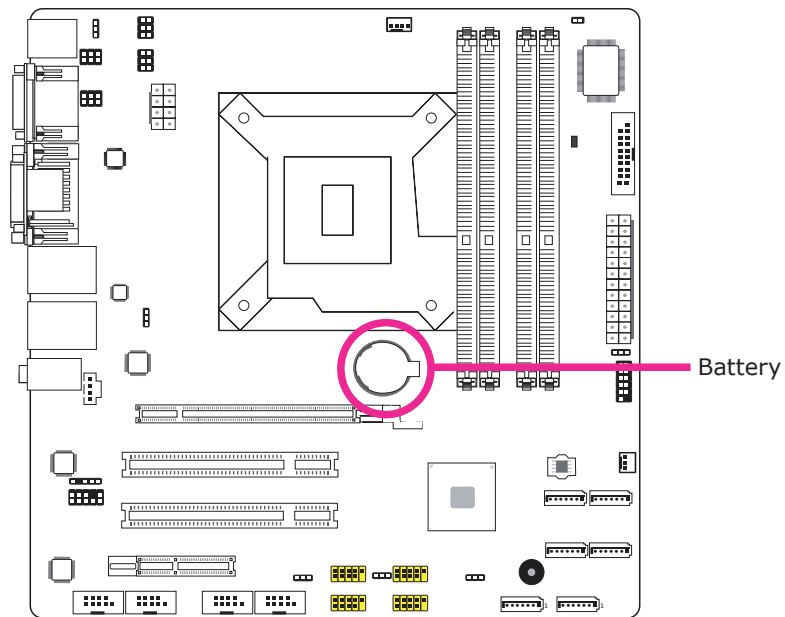

The lithium ion battery powers the real-time clock and CMOS memory. It is an auxiliary source of power when the main power is shut off.

Safety Measures

- Danger of explosion if battery incorrectly replaced.
- Replace only with the same or equivalent type recommend by the manufacturer.
- Dispose of used batteries according to local ordinance.

Chapter 3 - BIOS Setup

Overview

The BIOS is a program that takes care of the basic level of communication between the CPU and peripherals. It contains codes for various advanced features found in this system board. The BIOS allows you to configure the system and save the configuration in a battery-backed CMOS so that the data retains even when the power is off. In general, the information stored in the CMOS RAM of the EEPROM will stay unchanged unless a configuration change has been made such as a hard drive replaced or a device added.

It is possible that the CMOS battery will fail causing CMOS data loss. If this happens, you need to install a new CMOS battery and reconfigure the BIOS settings.



Note:

The BIOS is constantly updated to improve the performance of the system board; therefore the BIOS screens in this chapter may not appear the same as the actual one. These screens are for reference purpose only.

Default Configuration

Most of the configuration settings are either predefined according to the Load Optimal Defaults settings which are stored in the BIOS or are automatically detected and configured without requiring any actions. There are a few settings that you may need to change depending on your system configuration.

Entering the BIOS Setup Utility

The BIOS Setup Utility can only be operated from the keyboard and all commands are keyboard commands. The commands are available at the right side of each setup screen.

The BIOS Setup Utility does not require an operating system to run. After you power up the system, the BIOS message appears on the screen and the memory count begins. After the memory test, the message "Press DEL to run setup" will appear on the screen. If the message disappears before you respond, restart the system or press the "Reset" button. You may also restart the system by pressing the <Ctrl> <Alt> and keys simultaneously.

Legends

Keys	Function
Right and Left arrows	Moves the highlight left or right to select a menu.
Up and Down arrows	Moves the highlight up or down between submenus or fields.
<Esc>	Exits to the BIOS Setup Utility.
+ (plus key)	Scrolls forward through the values or options of the highlighted field.
- (minus key)	Scrolls backward through the values or options of the highlighted field.
Tab	Selects a field.
<F1>	Displays General Help.
<F4>	Saves and exits the Setup program.
<Enter>	Press <Enter> to enter the highlighted submenu.

Scroll Bar

When a scroll bar appears to the right of the setup screen, it indicates that there are more available fields not shown on the screen. Use the up and down arrow keys to scroll through all the available fields.

Submenu

When "►" appears on the left of a particular field, it indicates that a submenu which contains additional options are available for that field. To display the submenu, move the highlight to that field and press <Enter>.

AMI BIOS Setup Utility

Main

The Main menu is the first screen that you will see when you enter the BIOS Setup Utility.

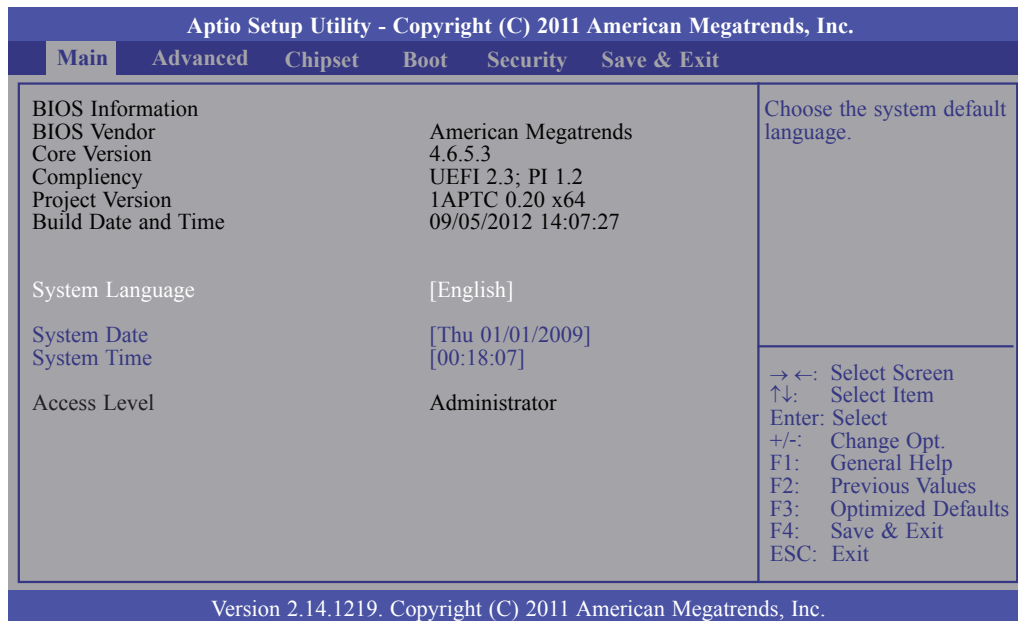

System Language

Choose the system default language.

System Date

The date format is <day>, <month>, <date>, <year>. Day displays a day, from Sunday to Saturday. Month displays the month, from January to December. Date displays the date, from 1 to 31. Year displays the year, from 1980 to 2099.

System Time

The time format is <hour>, <minute>, <second>. The time is based on the 24-hour military-time clock. For example, 1 p.m. is 13:00:00. Hour displays hours from 00 to 23. Minute displays minutes from 00 to 59. Second displays seconds from 00 to 59.

Advanced

The Advanced menu allows you to configure your system for basic operation. Some entries are defaults required by the system board, while others, if enabled, will improve the performance of your system or let you set some features according to your preference.



Important:

Setting incorrect field values may cause the system to malfunction.

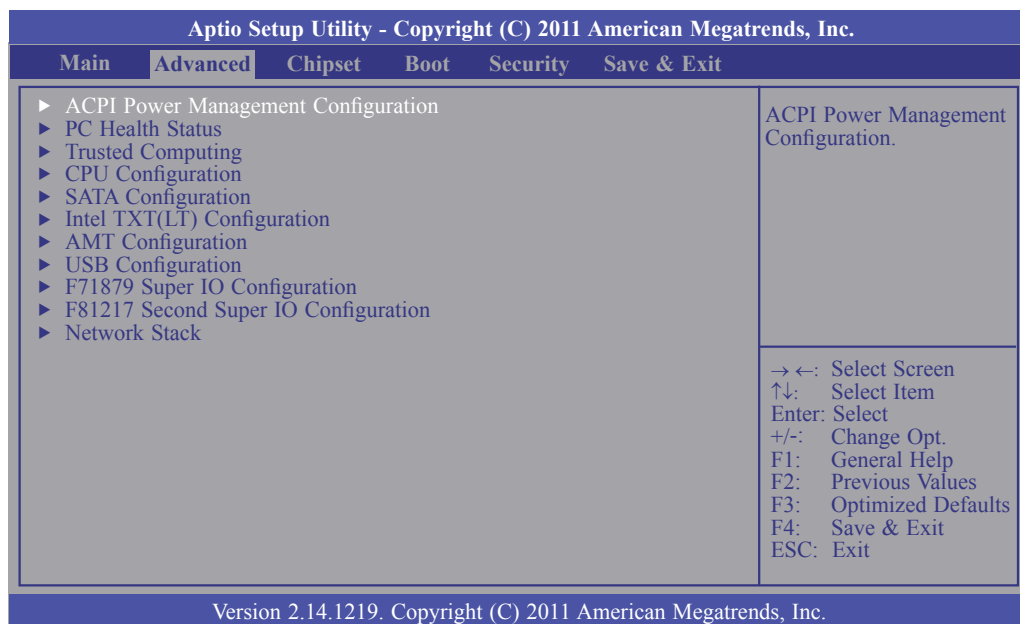

Launch PXE OpROM

Enables or disables the boot option for legacy network devices.

Launch Storage OpROM

Enables or disables the boot option for legacy mass storage devices with option ROM.

ACPI Power Management Configuration

This section is used to configure the ACPI Power Management.

Aptio Setup Utility - Copyright (C) 2011 American Megatrends, Inc.	
Advanced	
ACPI Power Management Configuration	
ACPI Sleep State	[S1 (Suspend to RAM)]
Resume by PME	[Disabled]
Resume by Ring	[Disabled]
Resume by RTC Alarm	[Disabled]
Select the highest ACPI sleep state the system will enter, when the SUSPEND button is pressed.	
→ ←: Select Screen ↑ ↓: Select Item Enter: Select +/-: Change Opt. F1: General Help F2: Previous Values F3: Optimized Defaults F4: Save & Exit ESC: Exit	
Version 2.14.1219. Copyright (C) 2011 American Megatrends, Inc.	

ACPI Sleep State

Selects the highest ACPI sleep state the system will enter when the Suspend button is pressed.

S1(POS) Enables the Power On Suspend function.

S3(STR) Enables the Suspend to RAM function.

Resume by PME

Enable this field to use the PME signal to wake up the system.

Resume by Ring

Set this field to Enabled to use the modem ring-on function. This will allow your system to power-on to respond to calls coming through an external or internal modem.

Resume by RTC Alarm

When Enabled, the system uses the RTC to generate a wakeup event.

PC Health Status

This section displays the SIO hardware health monitor.

Aptio Setup Utility - Copyright (C) 2011 American Megatrends, Inc.		
Advanced		
System Hardware Monitor		Smart Fan Function
▶ Smart Fan Function		
Case Open Beep	[Disabled]	
CPU Temperature	: +51 C	
System Temperature	: +27 C	
CPU FAN Speed	: 4132 RPM	
System FAN Speed	: N/A	
Vcore	: +0.960 V	
+5.0V	: +5.072 V	
+12V	: +12.056 V	
VDIMM	: +1.536 V	
+3.3V	: +3.328 V	
VSS5V	: +4.992V	
		→ ←: Select Screen ↑↓: Select Item Enter: Select +/-: Change Opt. F1: General Help F2: Previous Values F3: Optimized Defaults F4: Save & Exit ESC: Exit
Version 2.14.1219. Copyright (C) 2011 American Megatrends, Inc.		

Smart Fan Function

Aptio Setup Utility - Copyright (C) 2011 American Megatrends, Inc.		
Advanced		
CPU Smart Fan Control	[Automatic]	Enable CPU SmartFan
Boundary 1	60	
Boundary 2	50	
Boundary 3	40	
Boundary 4	30	
Speed Count 1	100	
Speed Count 2	75	
Speed Count 3	50	
Speed Count 4	40	
Speed Count 5	30	
System Smart Fan(1) Control	[Automatic]	
Boundary 1	60	
Boundary 2	50	
Boundary 3	40	
Boundary 4	30	
Speed Count 1	100	
Speed Count 2	75	
Speed Count 3	50	
Speed Count 4	40	
Speed Count 5	30	
		→ ←: Select Screen ↑↓: Select Item Enter: Select +/-: Change Opt. F1: General Help F2: Previous Values F3: Optimized Defaults F4: Save & Exit ESC: Exit
Version 2.02.1205. Copyright (C) 2010 American Megatrends, Inc.		

CPU Smart Fan Control

When this feature is set to Automatic, the CPU's fan speed will rotate according to the CPU's temperature. The higher the temperature, the faster the speed of rotation.

Boundary 1 to Boundary 4

The range is from 0-127.

Speed Count 1 to Speed Count 5

The range is from 1-100.

Case Open Beep

Set this field to Enabled to allow the system to alert you of a chassis intrusion event.

Trusted Computing (optional)

This section configures settings relevant to Trusted Computing innovations.

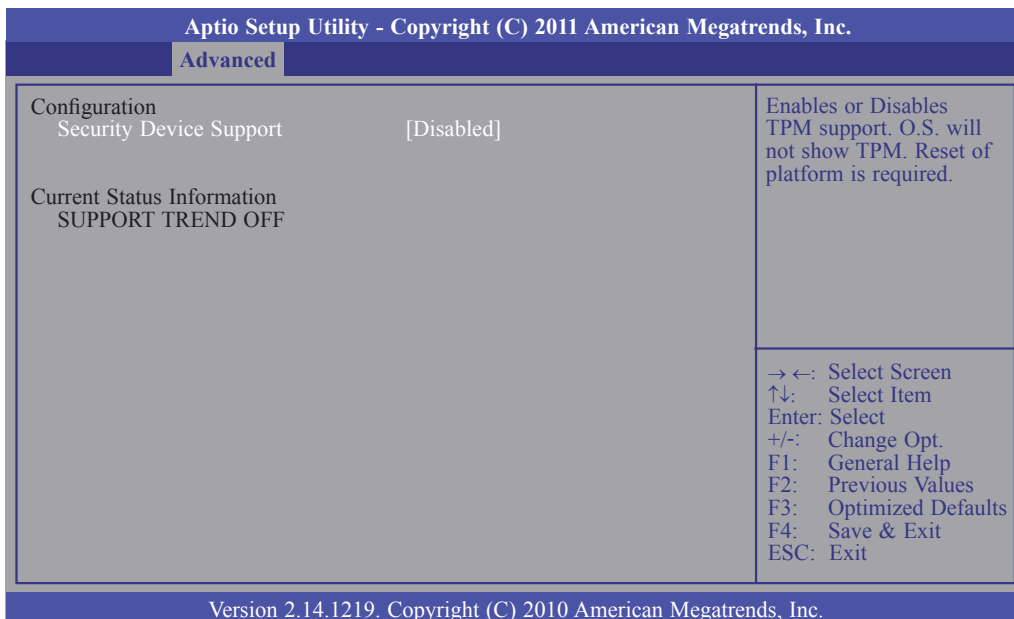

TPM Support

Enables or Disables TPM. O.S. will not show TPM. Resetting the platform is required.

CPU Configuration

This section is used to configure the CPU. It will also display the detected CPU information.

Aptio Setup Utility - Copyright (C) 2011 American Megatrends, Inc.		
Advanced		
CPU Configuration		Enable for Windows XP and Linux (OS optimized for hyper-threading technology) and disabled for other OS (OS not optimized for Hyper-Threading Technology). When disabled only one thread per enabled core is enabled.
Intel (R) Core (TM) i7-3770S CPU @ 3.40GHz		
CPU Signature	306a9	→ ←: Select Screen ↑ ↓: Select Item Enter: Select +/-: Change Opt. F1: General Help F2: Previous Values F3: Optimized Defaults F4: Save & Exit ESC: Exit
Microcode Patch	12	
Max CPU Speed	3400 MHz	
Min CPU Speed	1600 MHz	
CPU Speed	3400 MHz	
Processor Cores	4	
Intel HT Technology	Supported	
Intel VT-x Technology	Supported	
Intel SMX Technology	Supported	
64-bit	Supported	
L1 Data Cache	32 kB x 4	
L1 Code Cache	32 kB x 4	
L2 Cache	256 kB x 4	
L3 Cache	8192 kB	
Hyper-threading	[Enabled]	
Active Processor Cores	[All]	
Intel Virtualization Technology	[Disabled]	
Version 2.14.1219. Copyright (C) 2011 American Megatrends, Inc.		

Active Processor Cores

Number of cores to enable in each processor package.

Intel Virtualization Technology

When this field is set to Enabled, the VMM can utilize the additional hardware capabilities provided by Vanderpool Technology.

SATA Configuration

This section is used to configure SATA functions.

Aptio Setup Utility - Copyright (C) 2011 American Megatrends, Inc.		
Advanced		
SATA Controller(s)	[Enabled]	Enable or disable SATA device.
SATA Mode Selection	[IDE]	
Serial ATA Port 0	Empty	→ ←: Select Screen ↑↓: Select Item Enter: Select +/-: Change Opt. F1: General Help F2: Previous Values F3: Optimized Defaults F4: Save & Exit ESC: Exit
Software Preserve	Unknown	
Serial ATA Port 1	Empty	
Software Preserve	Unknown	
Serial ATA Port 2	Empty	
Software Preserve	Unknown	
Serial ATA Port 3	Empty	
Software Preserve	Unknown	
Serial ATA Port 4	Empty	
Software Preserve	Unknown	
Serial ATA Port 5	Empty	
Software Preserve	Unknown	

Version 2.14.1219. Copyright (C) 2011 American Megatrends, Inc.

SATA Mode

IDE Mode

This option configures the Serial ATA drives as Parallel ATA storage devices.

AHCI Mode

This option allows the Serial ATA devices to use AHCI (Advanced Host Controller Interface).

RAID Mode

This option allows you to create RAID or Intel Matrix Storage configuration on Serial ATA devices.

SATA Mode Selection

Determines how SATA controller(s) operate.

If AHCI or RAID is selected in the SATA Mode field, it will display the following information:



Aggressive LPM Support

Enable PCH to aggressively enter link power state.

SATA Controller Speed

Indicates the maximum speed the SATA controller can support.

Serial ATA Port 0 to Serial ATA Port 5

These fields are used to configure the connected SATA devices.

Intel TXT (LT) Configuration

This section is used to configure the Intel Trusted Execution technology.

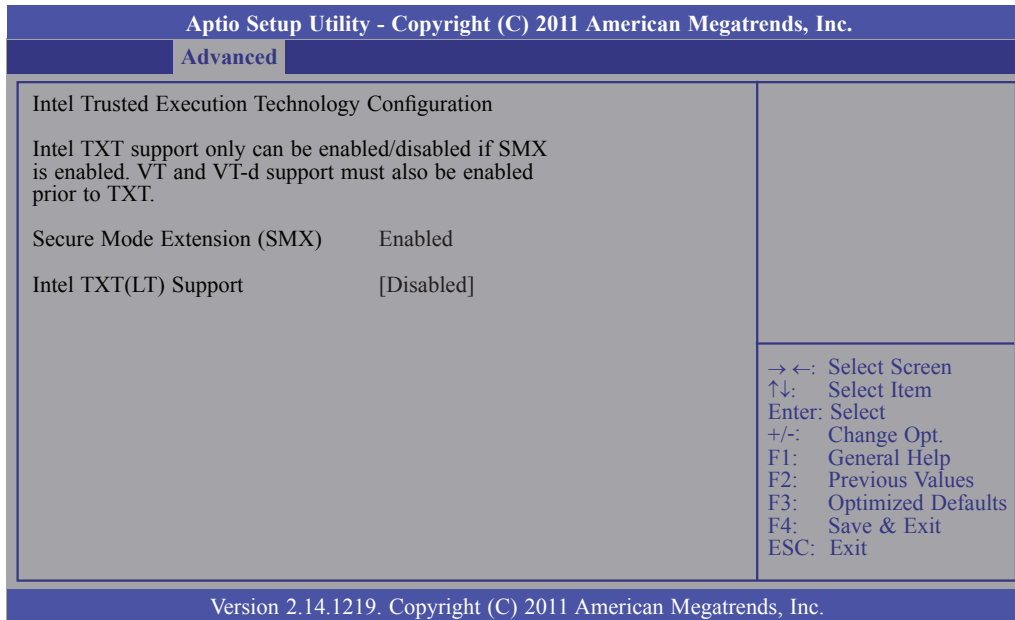

Intel TXT(LT) Support

The options are Enabled and Disabled.

AMT Configuration

This section is used to configure the AMT function.

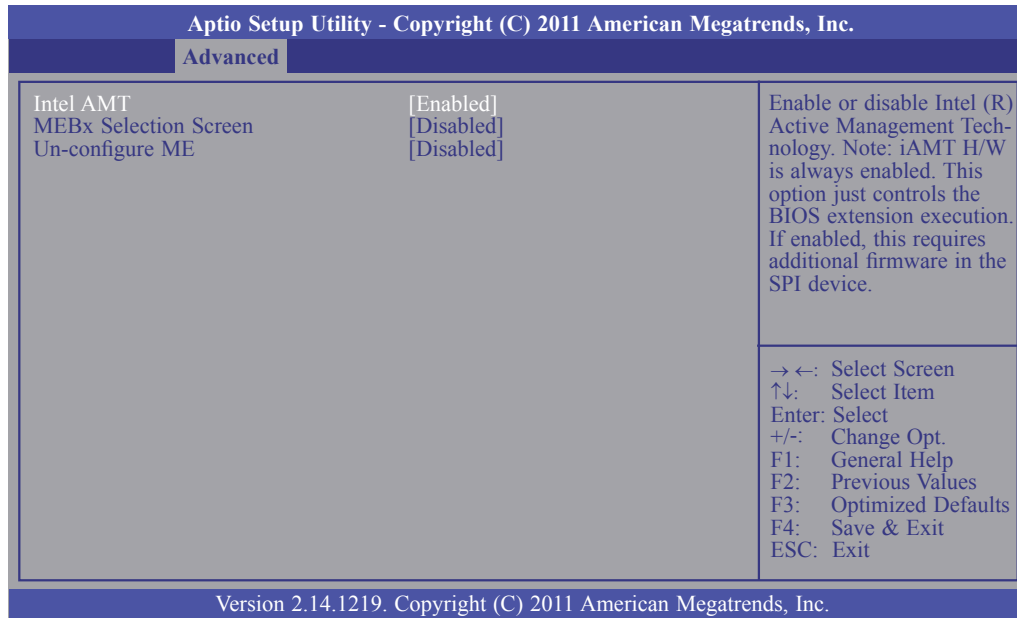

MEBx Selection Screen

OEMFLag Bit 2: enable or disable MEBx selection screen.

Un-configure ME

OEMFLag Bit 15: Un-configure ME without password.

USB Configuration

This section is used to configure USB.

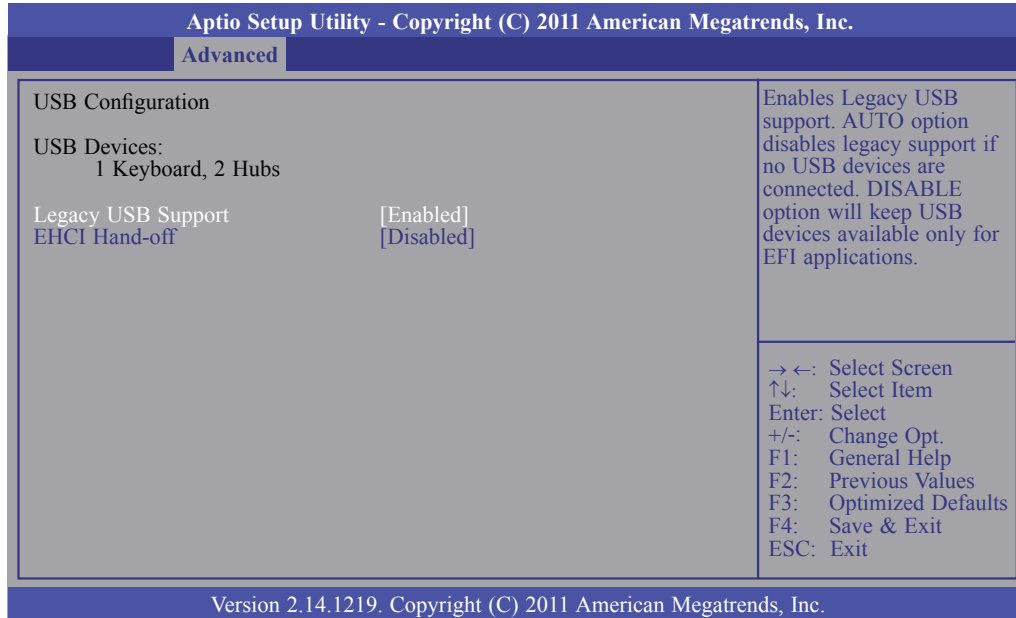

Legacy USB Support

Enabled

Enables legacy USB.

Auto

Disables support for legacy when no USB devices are connected.

Disabled

Keeps USB devices available only for EFI applications.

EHCI Hand-off

This is a workaround for OSEs that does not support EHCI hand-off. The EHCI ownership change should be claimed by the EHCI driver.

F71879 Super IO Configuration

This section is used to configure the I/O functions supported by the onboard Super I/O chip.

Aptio Setup Utility - Copyright (C) 2011 American Megatrends, Inc.		
Advanced		
F71879 Super IO Configuration		Restore AC Power Loss help.
Super IO Chip	Fintek F71879	
Restore AC Power Loss	[Power Off]	
WatchDog Timer	[Disabled]	
Super IO WatchDog Timer	10	
▶ Serial Port 1 Configuration		
▶ Serial Port 2 Configuration		
		→ ←: Select Screen ↑↓: Select Item Enter: Select +/-: Change Opt. F1: General Help F2: Previous Values F3: Optimized Defaults F4: Save & Exit ESC: Exit
Version 2.14.1219. Copyright (C) 2011 American Megatrends, Inc.		

Restore AC Power Loss

Off

When power returns after an AC power failure, the system's power is off. You must press the Power button to power-on the system.

On

When power returns after an AC power failure, the system will automatically power-on.

Last State

When power returns after an AC power failure, the system will return to the state where you left off before power failure occurs. If the system's power is off when AC power failure occurs, it will remain off when power returns. If the system's power is on when AC power failure occurs, the system will power-on when power returns.

WatchDog Timer

This field is used to select the time interval of the Watchdog timer. If the system hangs or fails to function, it will reset at the set time interval so that your system will continue to operate.

Serial Port 1 Configuration to Serial Port 2 Configuration

Aptio Setup Utility - Copyright (C) 2011 American Megatrends, Inc.		
Advanced		
Serial Port 1 Configuration		Enable or Disable Serial Port (COM)
Serial Port Device Settings	[Enabled] IO=3F8h; IRQ=4;	
Change Settings	[Auto]	
		→ ←: Select Screen ↑ ↓: Select Item Enter: Select +/-: Change Opt. F1: General Help F2: Previous Values F3: Optimized Defaults F4: Save & Exit ESC: Exit
Version 2.14.1219. Copyright (C) 2011 American Megatrends, Inc.		

Aptio Setup Utility - Copyright (C) 2011 American Megatrends, Inc.		
Advanced		
Serial Port 2 Configuration		Enable or Disable Serial Port (COM)
Serial Port Device Settings	[Enabled] IO=2F8h; IRQ=3;	
Change Settings	[Auto]	
		→ ←: Select Screen ↑ ↓: Select Item Enter: Select +/-: Change Opt. F1: General Help F2: Previous Values F3: Optimized Defaults F4: Save & Exit ESC: Exit
Version 2.14.1219. Copyright (C) 2011 American Megatrends, Inc.		

Serial Port

Enables or disables the serial port.

Change Settings

Selects the IO/IRQ setting of the I/O device.

Second Super IO Configuration

This section is used to configure the serial port functions.

Aptio Setup Utility - Copyright (C) 2011 American Megatrends, Inc.	
Advanced	
Second Super IO Configuration Super IO Chip F81217 SecondIo ▶ Serial Port 3 Configuration ▶ Serial Port 4 Configuration ▶ Serial Port 5 Configuration ▶ Serial Port 6 Configuration	Set Parameters of Serial Port 3 (COMA) → ←: Select Screen ↑ ↓: Select Item Enter: Select +/-: Change Opt. F1: General Help F2: Previous Values F3: Optimized Defaults F4: Save & Exit ESC: Exit
Version 2.14.1219. Copyright (C) 2011 American Megatrends, Inc.	

Serial Port 3 Configuration to Serial Port 6 Configuration

Aptio Setup Utility - Copyright (C) 2011 American Megatrends, Inc.	
Advanced	
Serial Port 3 Configuration Serial Port [Enabled] Device Settings IO=220h; IRQ=5; Change Settings [Auto] Device mode [Serial Port Fuctio...]	Enable or Disable Serial Port (COM) → ←: Select Screen ↑ ↓: Select Item Enter: Select +/-: Change Opt. F1: General Help F2: Previous Values F3: Optimized Defaults F4: Save & Exit ESC: Exit
Version 2.14.1219. Copyright (C) 2011 American Megatrends, Inc.	

Serial Port

Enables or disables the serial port.

Change Settings

Selects the IO/IRQ setting of the I/O device.

Network Stack

This section configures settings relevant to the network stack Configuration.

Aptio Setup Utility - Copyright (C) 2011 American Megatrends, Inc.		
Advanced		
Network Stack	[Enabled]	Enable or disable UEFI network stack.
		→ ←: Select Screen ↑ ↓: Select Item Enter: Select +/-: Change Opt. F1: General Help F2: Previous Values F3: Optimized Defaults ESC: Exit
Version 2.14.1219. Copyright (C) 2011 American Megatrends, Inc.		

Chipset

Configures relevant chipset functions.

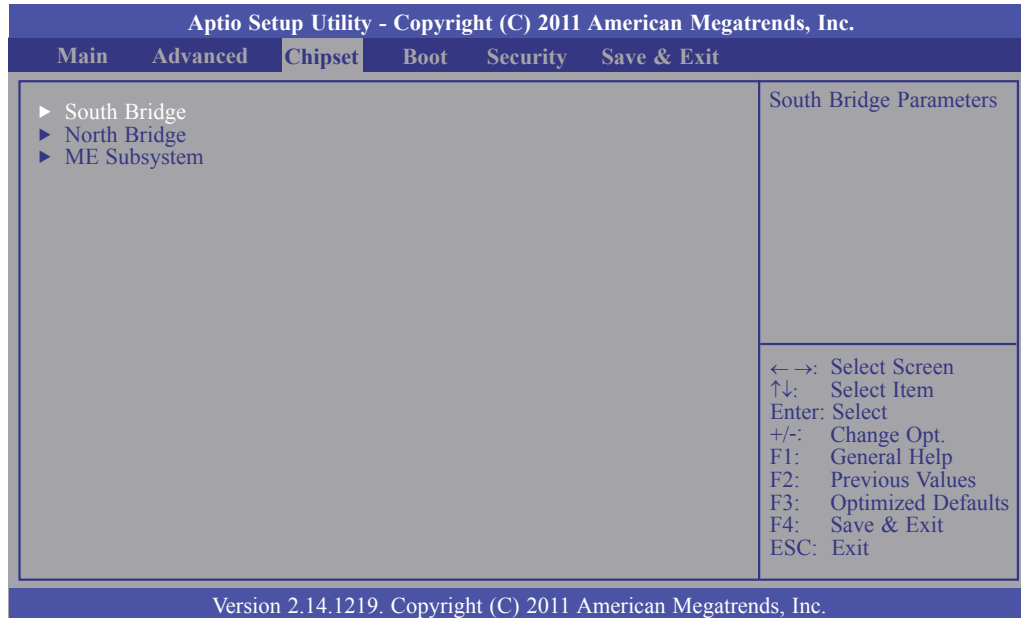

South Bridge

Aptio Setup Utility - Copyright (C) 2011 American Megatrends, Inc.		
Chipset		
Intel PCH RC Version	1.5.0.0	PCI Express Configuration Settings.
Intel PCH SKU name	Q67	
Intel pCH Rev ID	05/B3	
▶ PCI Express Configuration		
▶ USB Configuration		
PCH 82579 LAN Controller	[Enabled]	
Wake on LAN	[Enabled]	
High Precision Event Timer Configuration		→ ←: Select Screen ↑↓: Select Item Enter: Select +/-: Change Opt. F1: General Help F2: Previous Values F3: Optimized Defaults F4: Save & Exit ESC: Exit
High Precision Timer	[Enabled]	
After G3	[Power on]	

Version 2.14.1219. Copyright (C) 2011 American Megatrends, Inc.

PCH 82579 LAN Controller

Enables or disables LAN.

Wake on Lan

Enabled or disable intergrated LAN to wake the system. (The Wake On LAN cannot be disabled if ME is on at Sx state.)

High Precision Timer

Enables or disables the high precision event timer.

After G3

Power Off / WOL

Power-on the system via WOL after G3.

Power On

Power-on the system after G3.

PCI Express Configuration

Aptio Setup Utility - Copyright (C) 2011 American Megatrends, Inc.		
Chipset		
PCI Express Ports Configuration Onboard 8111DL LAN Controller [Enabled] PCIE2 Slot Speed [Gen 1]		Control the PCI Express Root port. → ←: Select Screen ↑ ↓: Select Item Enter: Select +/-: Change Opt. F1: General Help F2: Previous Values F3: Optimized Defaults F4: Save & Exit ESC: Exit
Version 2.14.1219. Copyright (C) 2011 American Megatrends, Inc.		

PCIE2 Slot Speed

Select PCI Express port speed.

USB Configuration

Aptio Setup Utility - Copyright (C) 2011 American Megatrends, Inc.		
Chipset		
USB Configuration EHCI 1 [Enabled] EHCI 2 [Enabled] USB Ports Per-Port Disable Control [Enabled] USB Port #0 Disable [Enabled] USB Port #1 Disable [Enabled] USB Port #2 Disable [Enabled] USB Port #3 Disable [Enabled] USB Port #4 Disable [Enabled] USB Port #5 Disable [Enabled] USB Port #8 Disable [Enabled] USB Port #9 Disable [Enabled] USB Port #10 Disable [Enabled] USB Port #11 Disable [Enabled] USB Port #12 Disable [Enabled] USB Port #13 Disable [Enabled]		Control the USB EHCI (USB 2.0) functions. One EHCI controller must always be enabled. → ←: Select Screen ↑ ↓: Select Item Enter: Select +/-: Change Opt. F1: General Help F2: Previous Values F3: Optimized Defaults F4: Save & Exit ESC: Exit
Version 2.14.1219. Copyright (C) 2011 American Megatrends, Inc.		

EHCI Controller 1 and EHCI Controller 2

These fields are used to enable or disable Enhanced Host Controller Interface (USB 2.0).

USB Ports Per-Port Disable Control

Control each of the USB ports (0-13) disabling.

USB Port 0 to USB Port 13

Enables or disables the selected USB port.

North Bridge

Aptio Setup Utility - Copyright (C) 2011 American Megatrends, Inc.		
Chipset		
System Agent Bridge Name	Ivy Bridge	Check to enable VT-d function on MCH
System Agent RC Version	1.5.0.0	
VT-d Capability	Supported	
VT-d	[Enabled]	
<ul style="list-style-type: none"> ▶ Graphics Configuration ▶ NB PCIe Configuration ▶ Memory Configuration 		
		→ ←: Select Screen ↑ ↓: Select Item Enter: Select +/-: Change Opt. F1: General Help F2: Previous Values F3: Optimized Defaults F4: Save & Exit ESC: Exit
Version 2.14.1219. Copyright (C) 2011 American Megatrends, Inc.		

VT-d

Check to enable VT-d function on MCH.

Graphics Configuration

Aptio Setup Utility - Copyright (C) 2011 American Megatrends, Inc.		
Chipset		
Graphics Configuration		Select which of IGFX/ PEG/PCI graphics device should be primary display or select SG for switch- able Gfx.
IGFX VBIOS Version	2137	
IGfx Frequency	350 MHz	
Primary Display	[Auto]	
Internal Graphics	[Auto]	
DVMT Pre-Allocated	[64M]	
DVMT Total Gfx Mem	[256M]	
		→ ←: Select Screen ↑ ↓: Select Item Enter: Select +/-: Change Opt. F1: General Help F2: Previous Values F3: Optimized Defaults F4: Save & Exit ESC: Exit
Version 2.14.1219. Copyright (C) 2011 American Megatrends, Inc.		

Internal Graphics

Keep IGD enabled based on the setup options.

DVMT Pre-Allocated

Select DVMT 5.0 Pre-Allocated (Fixed) Graphics Memory size used by the internal graphics device.

DVMT Total Gfx Memory

Select DVMT 5.0 Total Graphics Memory size used by the internal graphics device.

NB PCIe Configuration

Aptio Setup Utility - Copyright (C) 2011 American Megatrends, Inc.		
Chipset		
NB PCIe Configuration	Not Present	Configure PEG B0:D1:F0. Gen1-Gen3
PEG	[Gen1]	
PEG - Gen x		
Enable PEG	[Enabled]	
		→ ←: Select Screen ↑↓: Select Item Enter: Select +/-: Change Opt. F1: General Help F2: Previous Values F3: Optimized Defaults F4: Save & Exit ESC: Exit
Version 2.14.1219. Copyright (C) 2011 American Megatrends, Inc.		

Enable PEG

To enable or disable the PEG.

Memory Configuration

Aptio Setup Utility - Copyright (C) 2011 American Megatrends, Inc.		
Chipset		
Memory Information		
Memory RC Version	1.5.0.0	→ ←: Select Screen ↑↓: Select Item Enter: Select +/-: Change Opt. F1: General Help F2: Previous Values F3: Optimized Defaults F4: Save & Exit ESC: Exit
Memory Frequency	1333 Mhz	
Total Memory	1024 MB (DDR3)	
DIMM#0	1024 MB (DDR3)	
DIMM#1	Not Present	
DIMM#2	Not Present	
DIMM#3	Not Present	
CAS Latency (tCL)	9	
Minimum delay time		
CAS to RAS (tRCDmin)	9	
ROW Precharge (tRPmin)	9	
Active to Precharge (tRASmin)	24	
XMP Profile 1	Not Supported	
XMP Profile 2	Not Supported	
Version 2.14.1219. Copyright (C) 2011 American Megatrends, Inc.		

ME Subsystem

Aptio Setup Utility - Copyright (C) 2011 American Megatrends, Inc.

Chipset

Intel ME Subsystem Configuration	
ME FW Version	8.0.4.1441

→←: Select Screen
↑↓: Select Item
Enter: Select
+/-: Change Opt.
F1: General Help
F2: Previous Values
F3: Optimized Defaults
F4: Save & Exit
ESC: Exit

Version 2.14.1219. Copyright (C) 2011 American Megatrends, Inc.

Boot

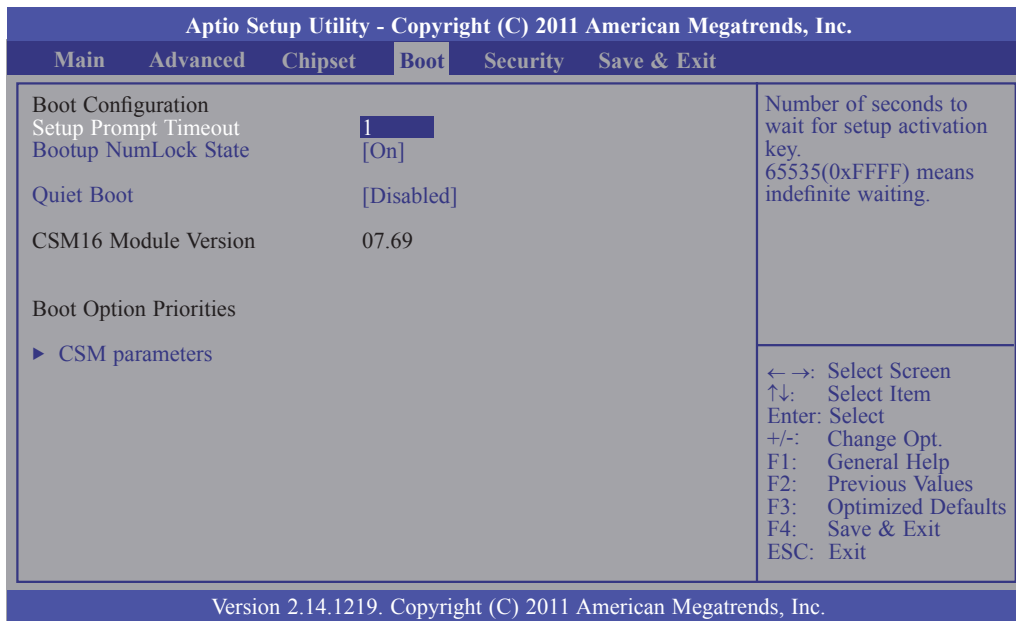

Setup Prompt Timeout

Selects the number of seconds to wait for the setup activation key. 65535(0xFFFF) denotes indefinite waiting.

Bootup NumLock State

This allows you to determine the default state of the numeric keypad. By default, the system boots up with NumLock on wherein the function of the numeric keypad is the number keys. When set to Off, the function of the numeric keypad is the arrow keys.

Quiet Boot

Enables or disables the quiet boot function.

CSM Parameters

Aptio Setup Utility - Copyright (C) 2011 American Megatrends, Inc.		
Boot		
Launch CSM	[Always]	This option controls if CSM will be launched.
Boot option filter	[UEFI and Legacy]	
Launch PXE OpROM policy	[Do not launch]	
Launch Storage OpROM policy	[Legacy only]	
Other PCI device ROM priority	[Legacy OpROM]	
		← →: Select Screen ↑↓: Select Item Enter: Select +/-: Change Opt. F1: General Help F2: Previous Values F3: Optimized Defaults F4: Save & Exit ESC: Exit
Version 2.14.1219. Copyright (C) 2011 American Megatrends, Inc.		

Boot option filter

This option controls what devices system can boot to.

Launch PXE OpROM policy

Controls the execution of UEFI and Legacy PXE OpROM.

Launch Storage OpROM policy

Controls the execution of UEFI and Legacy Storage OpROM.

Other PCI device ROM priority

For PCI devices other than Network, Mass storage or video defines which OpROM to launch.

Security

Aptio Setup Utility - Copyright (C) 2011 American Megatrends, Inc.					
Main	Advanced	Chipset	Boot	Security	Save & Exit
Password Description If ONLY the Administrator's password is set, then this only limits access to Setup and is only asked for when entering Setup. If ONLY the User's password is set, then this is a power on password and must be entered to boot or enter Setup. In Setup the User will have Administrator rights. The password length must be in the following range: Minimum length 3 Maximum length 20				Set Setup Administrator Password	
Administrator Password User Password UEFI Secure Boot Management				→ ←: Select Screen ↑ ↓: Select Item Enter: Select +/-: Change Opt. F1: General Help F2: Previous Values F3: Optimized Defaults F4: Save & Exit ESC: Exit	
Version 2.14.1219. Copyright (C) 2011 American Megatrends, Inc.					

Administrator Password

Sets the administrator password.

User Password

Sets the user password.

Save & Exit

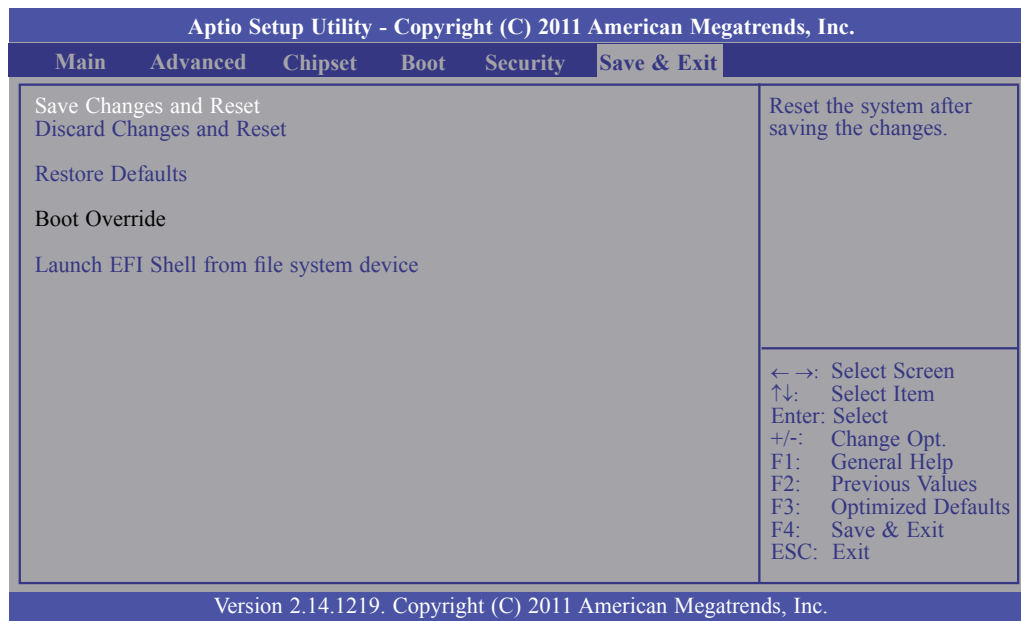

Save Changes and Reset

To save the changes, select this field and then press <Enter>. A dialog box will appear. Select Yes to reset the system after saving all changes made.

Discard Changes and Reset

To discard the changes, select this field and then press <Enter>. A dialog box will appear. Select Yes to reset the system setup without saving any changes.

Restore Defaults

To restore and load the optimized default values, select this field and then press <Enter>. A dialog box will appear. Select Yes to restore the default values of all the setup options.

Launch EFI Shell from file system device

Attempts to launch EFI shell application (Shellx64.efi) from one of the available filesystem devices.

Updating the BIOS

To update the BIOS, you will need the new BIOS file and a flash utility, AFUDOS.EXE. Please contact technical support or your sales representative for the files.

To execute the utility, type:

```
A:> AFUDOS BIOS_File_Name /b /p /n
```

then press <Enter>.

```
C:\AFU\AFUDOS>afudos filename /B /P /N
+-----+
|               AMI Firmware Update Utility(APTIO) v2.25               |
|               Copyright (C)2008 American Megatrends Inc. All Rights Reserved.               |
+-----+
Reading file ..... done
Erasing flash ..... done
Writing flash ..... done
Verifying flash ..... done
Erasing BootBlock ..... done
Writing BootBlock ..... done
Verifying BootBlock ..... done

C:\AFU\AFUDOS>
```

Chapter 4 - Supported Software

Install drivers, utilities and software applications that are required to facilitate and enhance the performance of the system board. You may acquire the software from your sales representatives, from an optional DVD included in the shipment, or from the website download page at <https://www.dfi.com/DownloadCenter>.

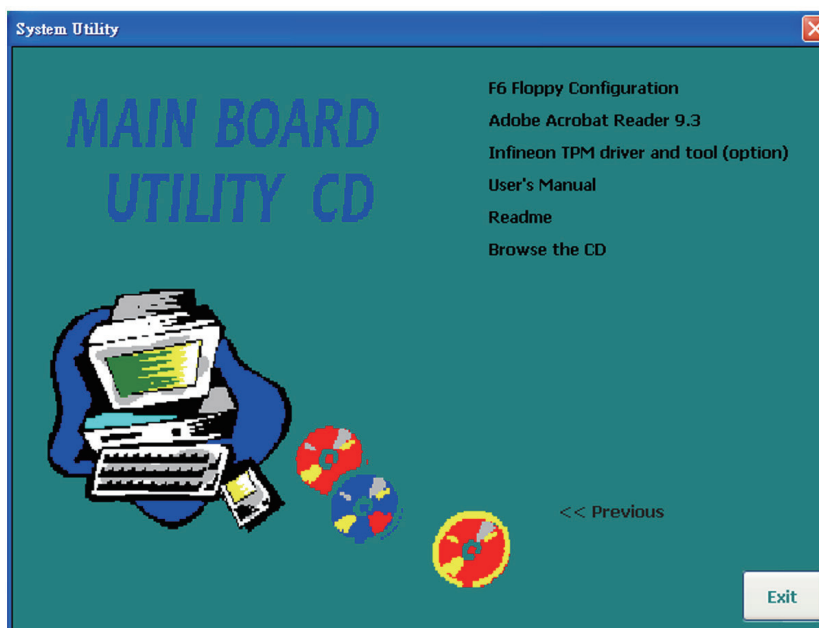
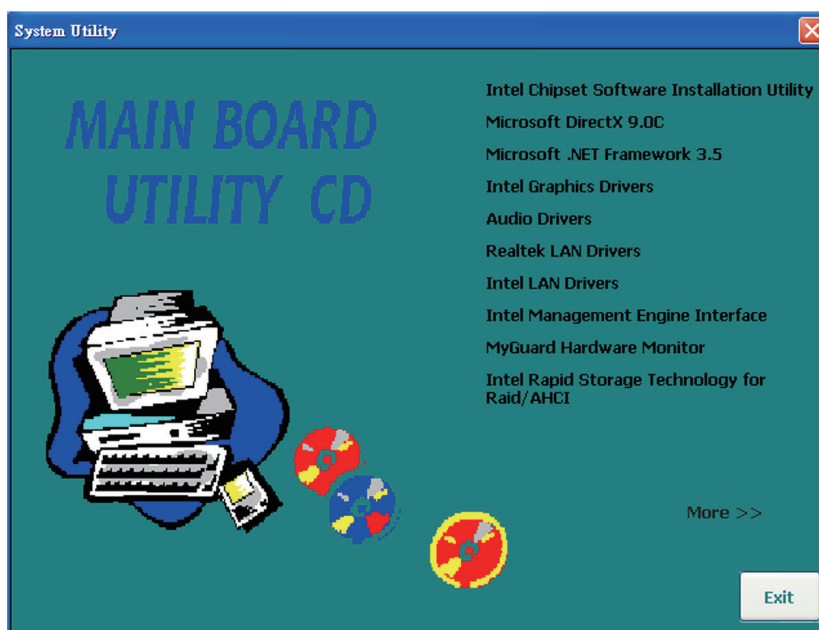

Intel Chipset Software Installation Utility

The Intel Chipset Software Installation Utility is used for updating Windows® INF files so that the Intel chipset can be recognized and configured properly in the system.

To install the utility, click "Intel Chipset Software Installation Utility" on the main menu.

1. Setup is now ready to install the utility. Click Next.



2. Read the license agreement then click Yes.



- Go through the readme document for system requirements and installation tips then click Next.

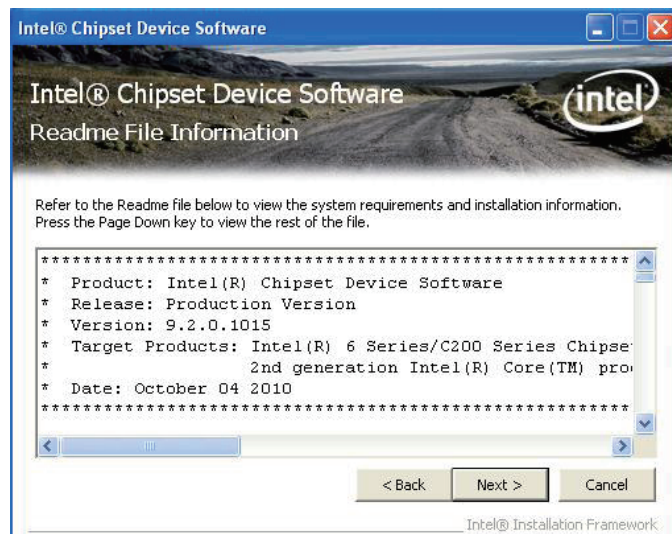

- Setup is now installing the driver. Click Next to continue.

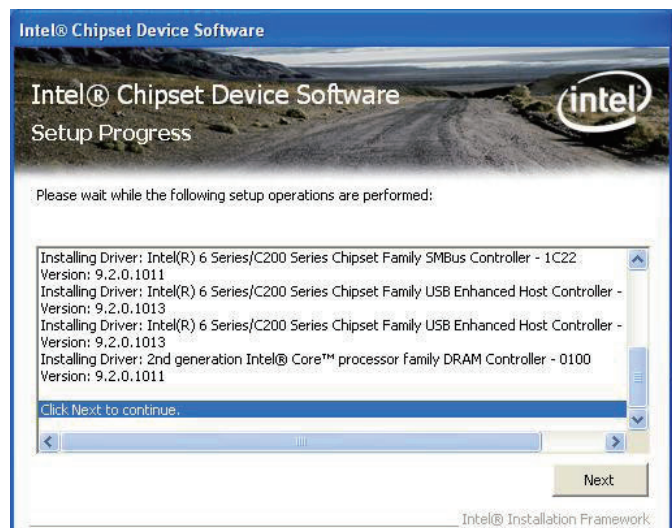

- Click "Yes, I want to restart this computer now" then click Finish.

Restarting the system will allow the new software installation to take effect.



Microsoft DirectX 9.0C Driver (for Windows XP only)

To install the utility, click "Microsoft DirectX 9.0C Driver" on the main menu.

1. Click "I accept the agreement" then click Next.



2. To start installation, click Next.

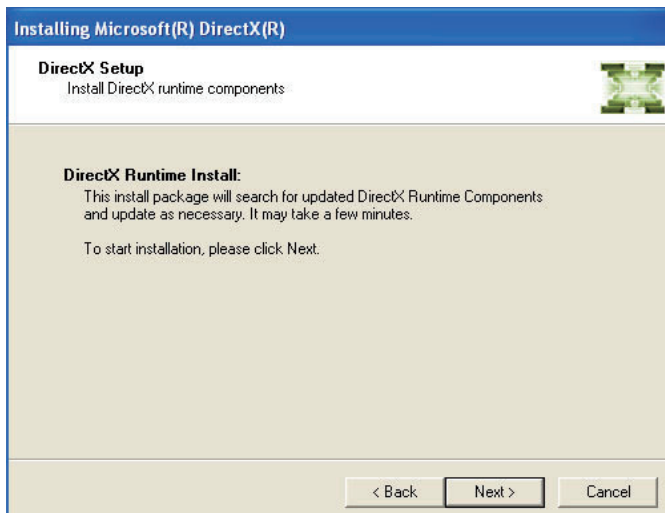

3. Click Finish. Reboot the system for DirectX to take effect.

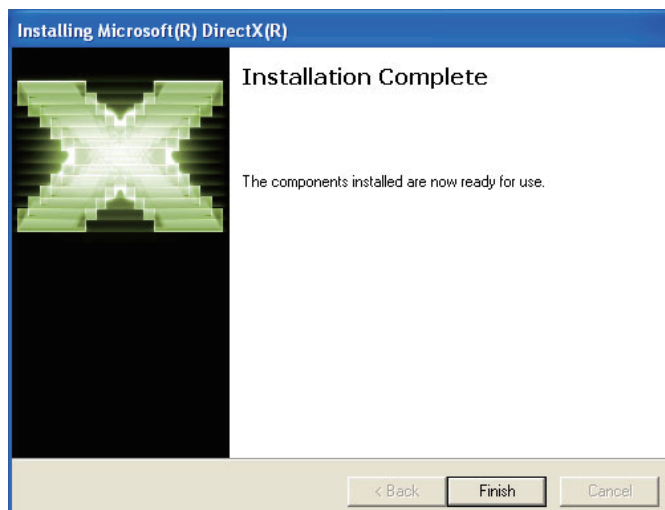

Microsoft .NET Framework 3.5 (for Windows XP only)

**Note:**

Before installing Microsoft .NET Framework 3.5, make sure you have updated your Windows XP operating system to Service Pack 3.

To install the driver, click "Microsoft .NET Framework 3.5" on the main menu.

1. Read the license agreement carefully.

Click "I have read and accept the terms of the License Agreement" then click Install.

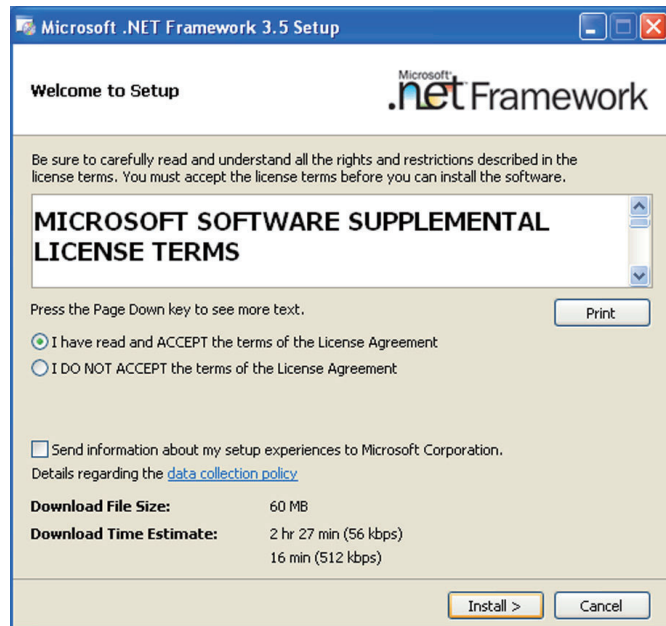

2. Setup is now installing the driver.

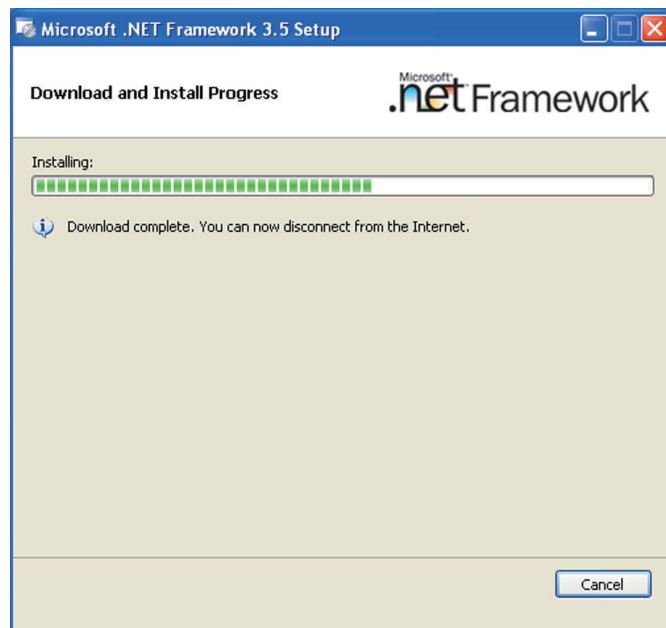

3. Click Exit.

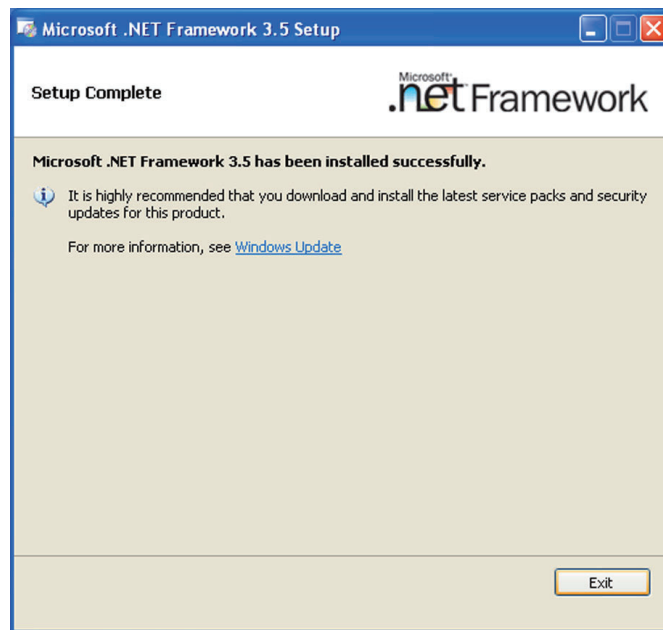

Intel Graphics Drivers (for Windows Vista)

To install the driver, click "Intel Graphics Drivers" on the main menu.

1. Setup is now ready to install the graphics driver. Click Next.



By default, the "Automatically run WinSAT and enable the Windows Aero desktop theme" is enabled. With this enabled, after installing the graphics driver and the system rebooted, the screen will turn blank for 1 to 2 minutes (while WinSAT is running) before the Windows Vista desktop appears. The "blank screen" period is the time Windows is testing the graphics performance.

We recommend that you skip this process by disabling this function then click Next.

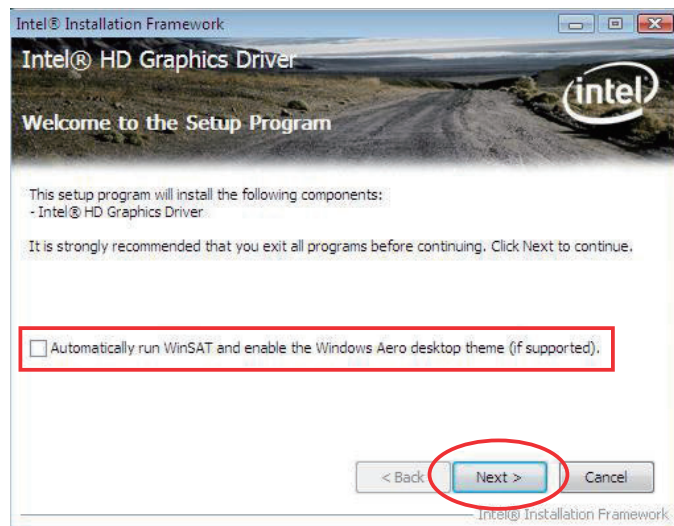

2. Read the license agreement then click Yes.

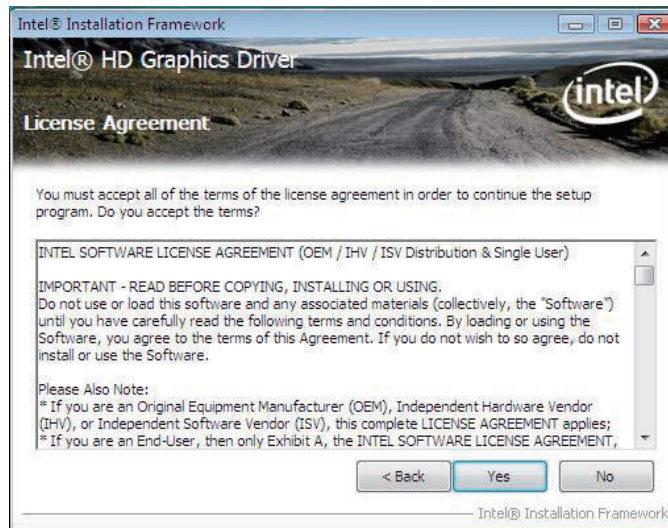

3. Go through the readme document for system requirements and installation tips then click Next.

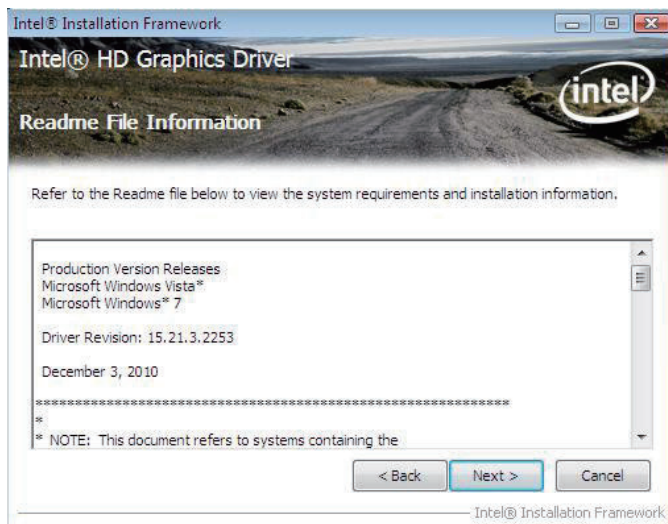

4. Setup is currently installing the driver. After installation has completed, click Next.

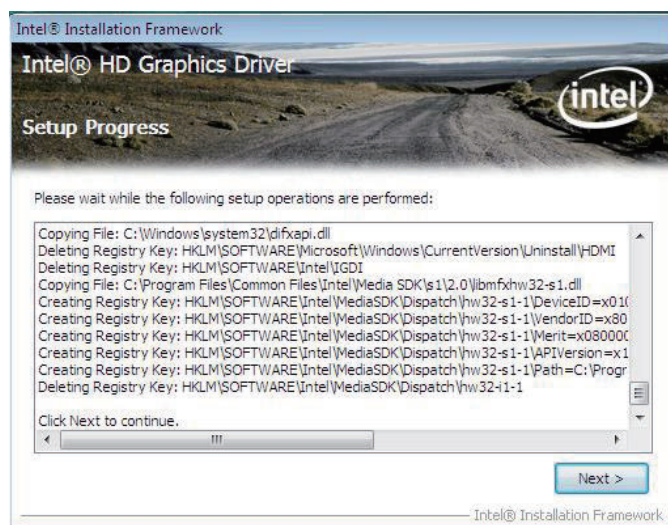

5. Click "Yes, I want to restart this computer now" then click Finish.

Restarting the system will allow the new software installation to take effect.

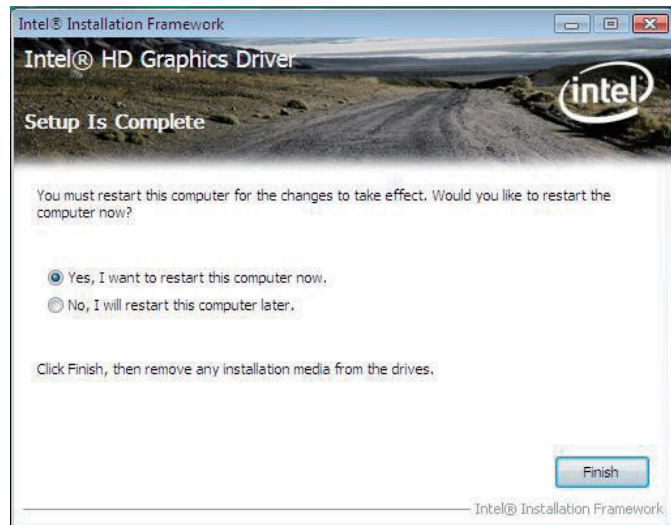

Intel Graphics Drivers (for Windows XP)

To install the driver, click "Intel Graphics Drivers" on the main menu.

1. Setup is ready to install the graphics driver. Click Next.

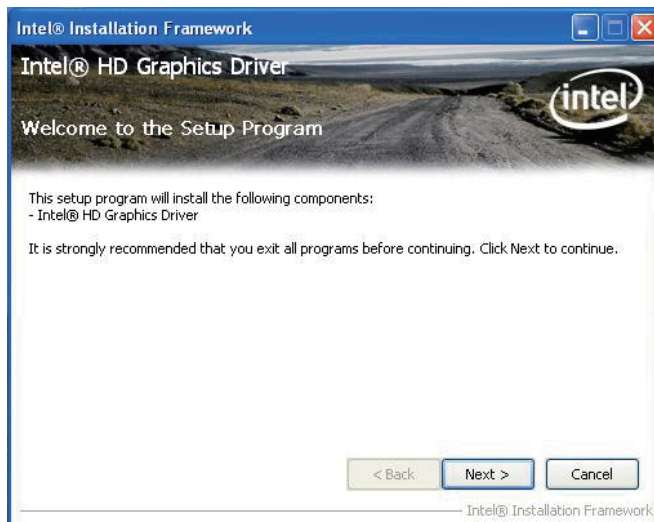

2. Read the license agreement then click Yes.



3. Go through the readme document for more installation tips then click Next.

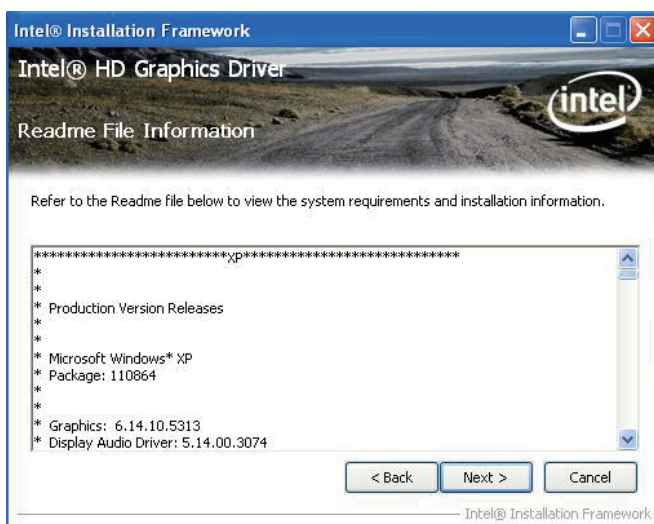

4. Setup is currently installing the driver. After installation has completed, click Next.

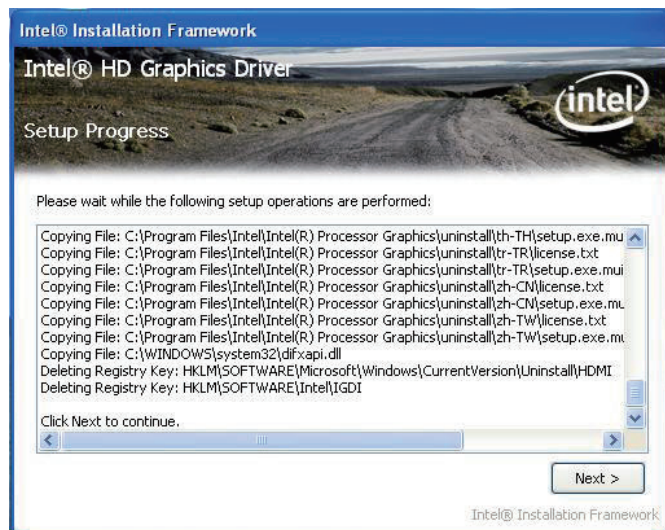

5. Click "Yes, I want to restart this computer now." then click Finish.

Restarting the system will allow the new software installation to take effect.

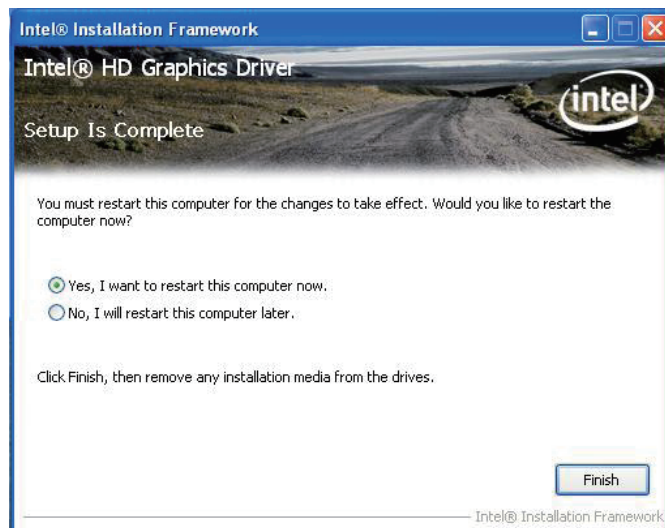

Audio Drivers

To install the driver, click "Audio Drivers" on the main menu.

1. Setup is now ready to install the audio driver. Click Next.
2. Follow the remainder of the steps on the screen; clicking "Next" each time you finish a step.

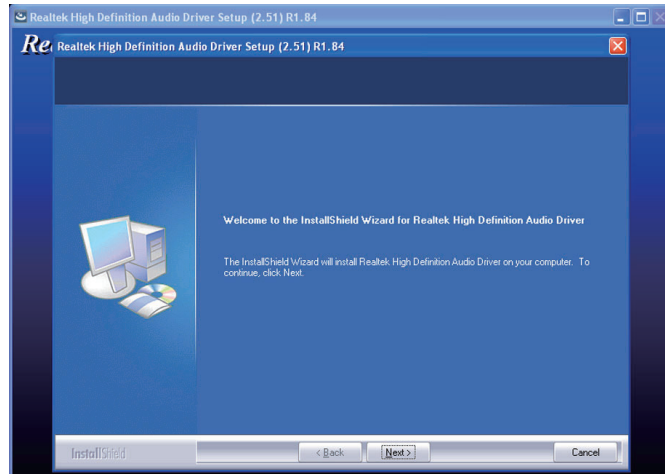

3. Click "Yes, I want to restart my computer now" then click Finish.

Restarting the system will allow the new software installation to take effect.

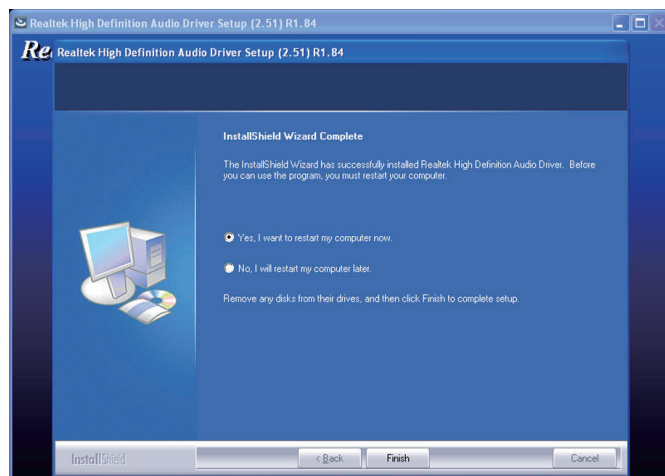

Realtek LAN Drivers

To install the driver, click "Realtek LAN Drivers" on the main menu.

1. Setup is ready to install the driver. Click Next.

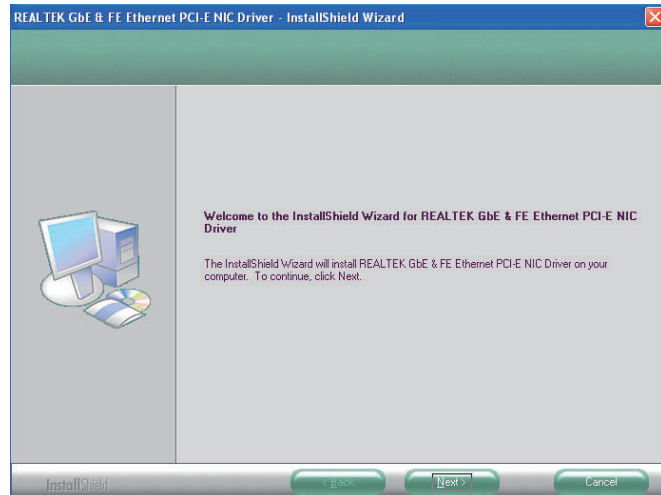

2. Click Install to begin the installation.

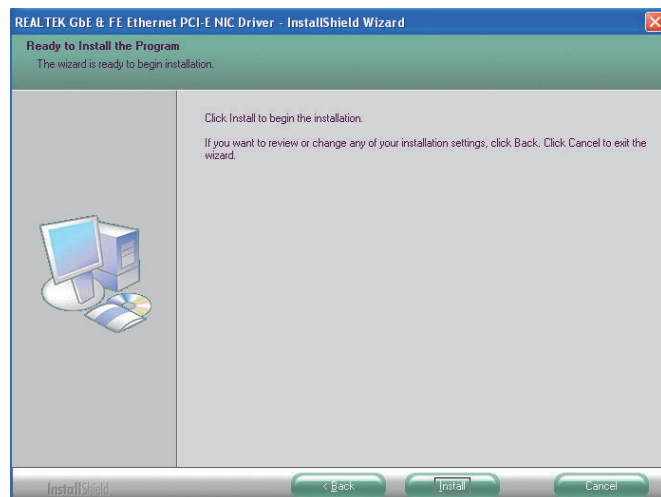

3. After completing installation, click Finish.

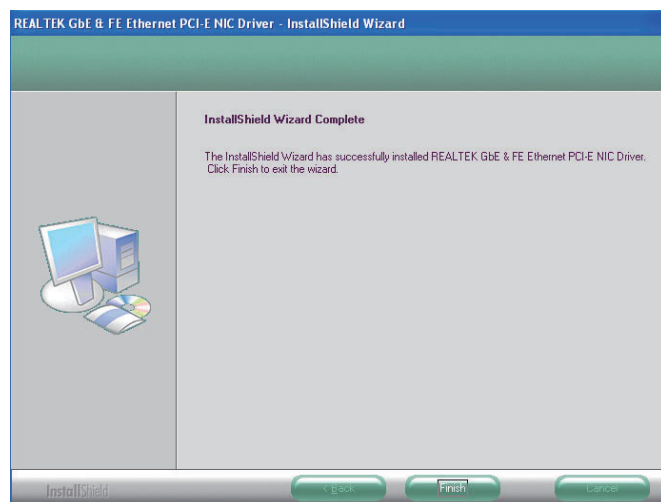

Intel LAN Drivers

To install the driver, click "Intel LAN Drivers" on the main menu.

1. Setup is ready to install the driver. Click Next.



2. Click "I accept the terms in the license agreement" then click "Next".

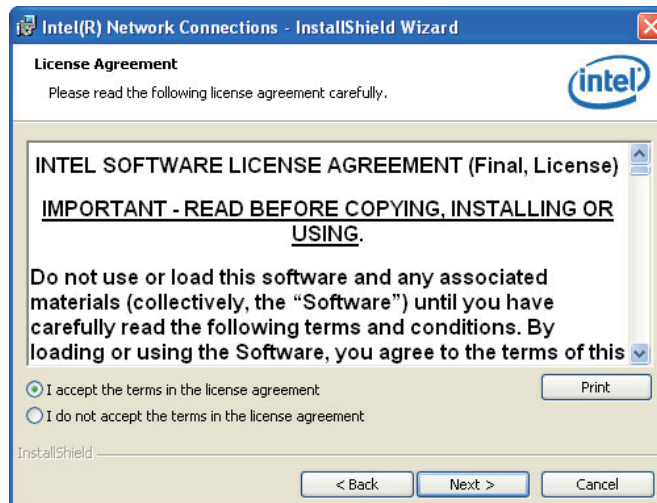

3. Select the program features you want installed then click Next.

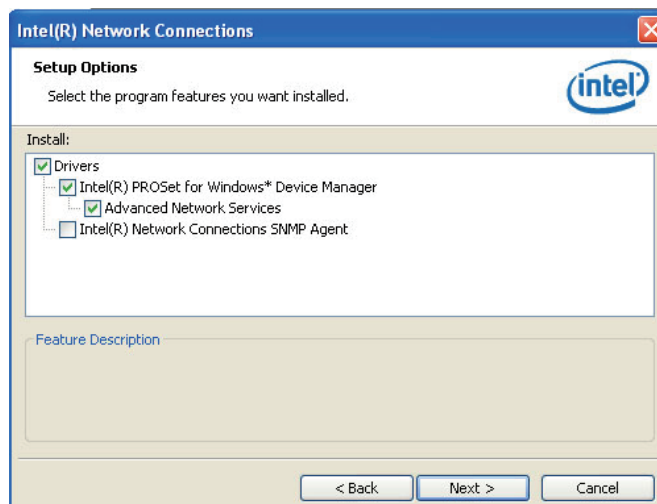

4. Click Install to begin the installation.

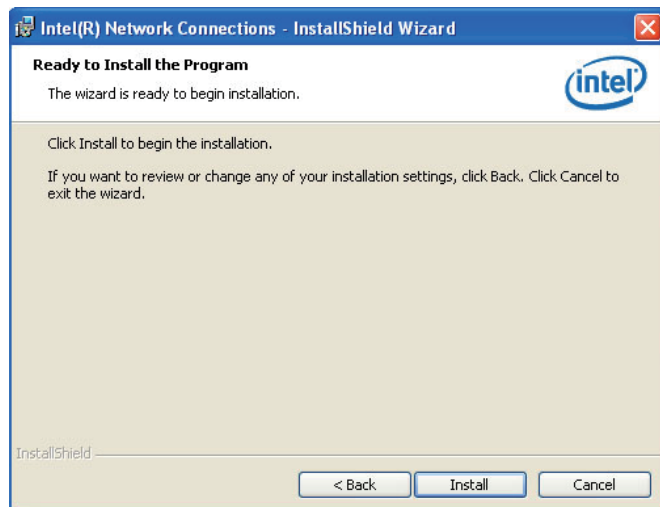

5. After completing installation, click Finish.

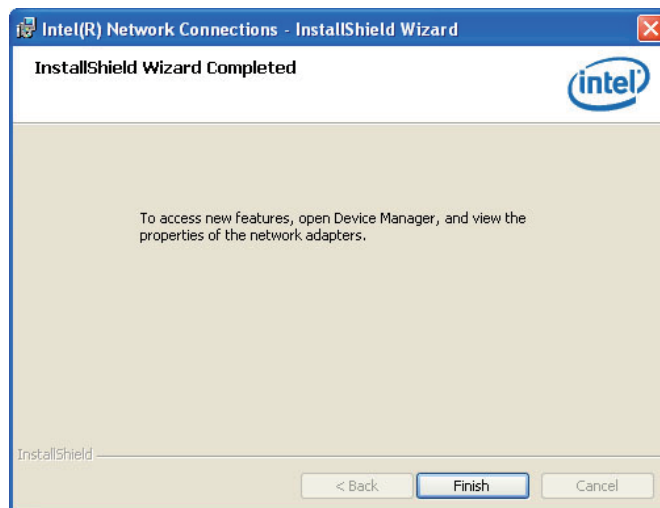

Intel Management Engine Interface

To install the driver, click "Intel Management Engine Interface" on the main menu.

1. Setup is ready to install the driver. Click Next.

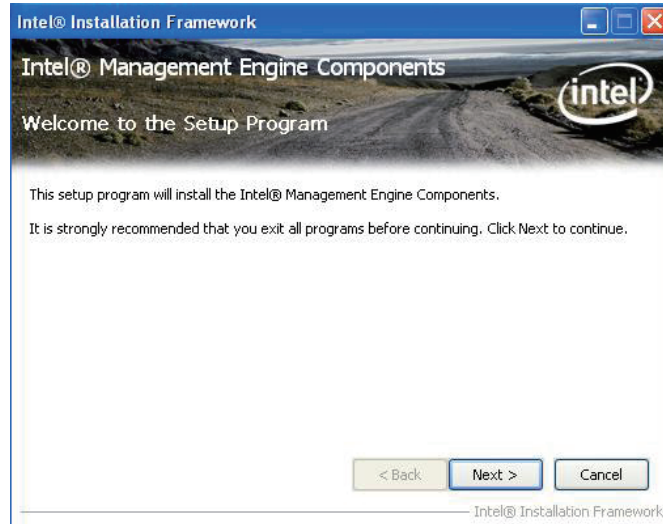

2. Read the license agreement then click Yes.



3. Go through the readme document for more installation tips then click Next.

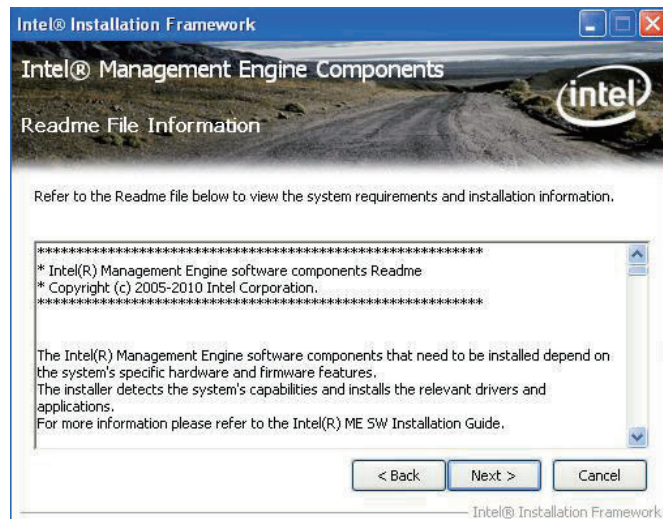

4. Setup is currently installing the driver. After installation has completed, click Next.

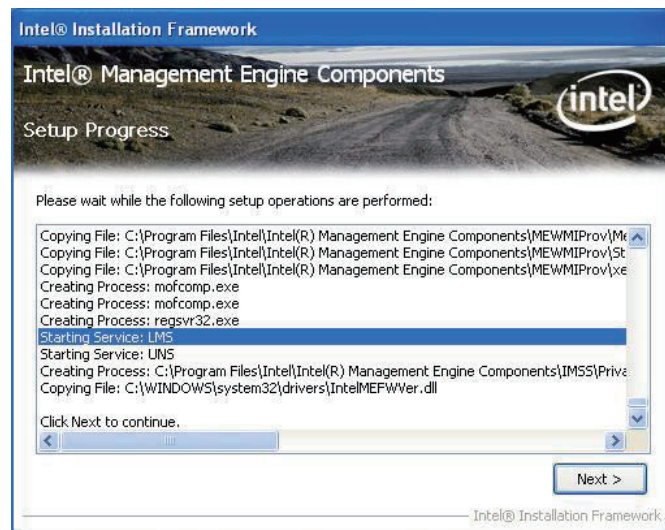

5. After completing installation, click Finish.



MyGuard Hardware Monitor

1. Locate for the MyGuard folder in the provided disc.
2. In the MyGuard folder, right-click on the "setup" file.
3. Select Run As Administrator.
4. Double-click Setup.

Important:
Perform steps 1-3 only when using Windows 7 or Windows Vista.

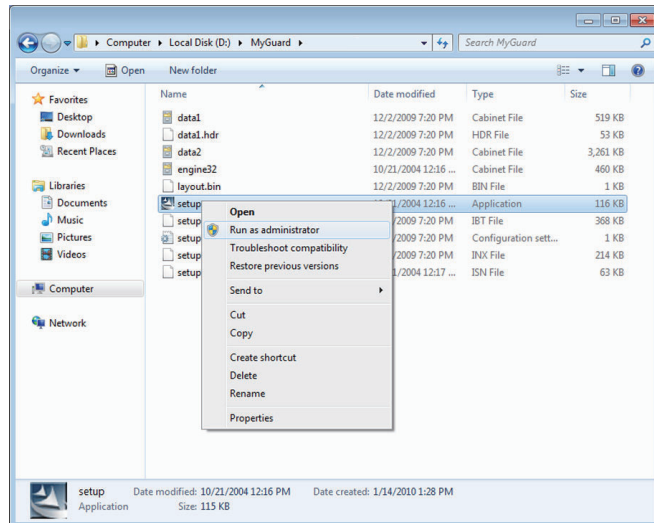

5. Setup is ready to install the utility. Click Next.

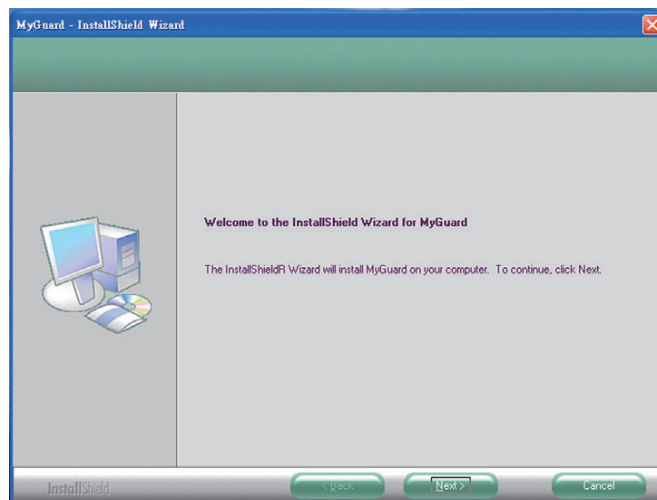

6. Click Install to begin installation.

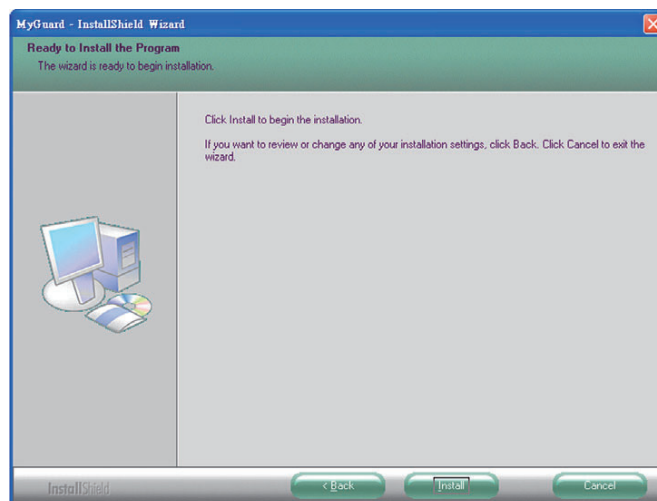

- Setup is currently installing the utility.

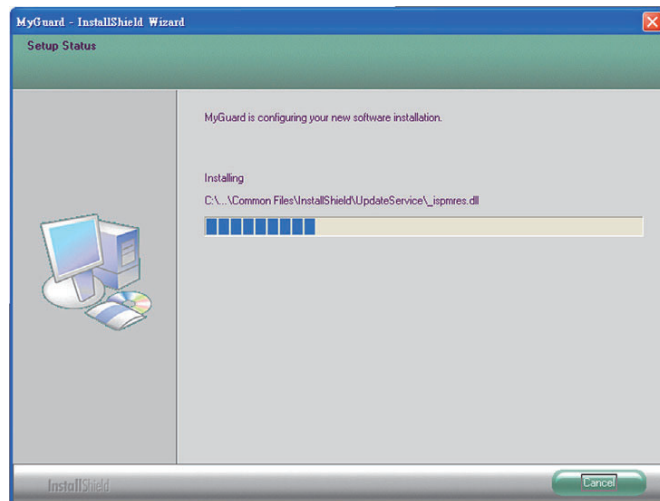

- After completing installation, click Finish to exit setup.

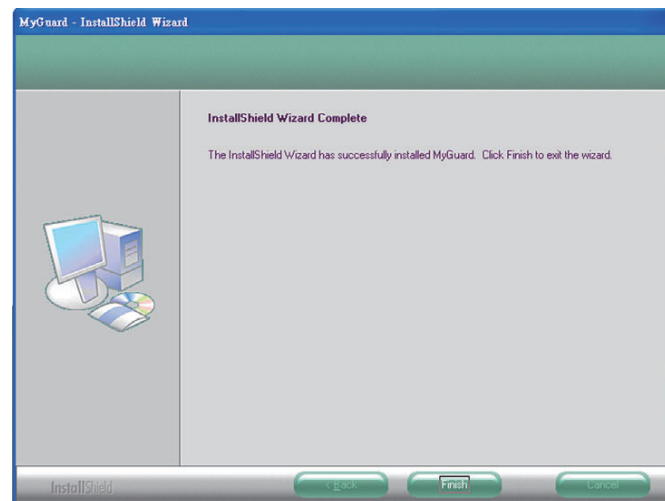

F6 Floppy Configuration Utility

This is used to create a floppy driver diskette needed when you install Windows® XP using the F6 installation method. This will allow you to install the operating system onto a hard drive when in AHCI mode.

1. Insert a blank floppy diskette.
2. Locate for the drivers in the CD then copy them to the floppy diskette. The CD includes drivers for both 32-bit and 64-bit operating systems. The path to the drivers are shown below.

32-bit

CD Drive:\AHCI_RAID\F6FLOPPY\f6flpy32

64-bit

CD Drive:\AHCI_RAID\F6FLOPPY\f6flpy64

Adobe Acrobat Reader 9.3

To install the reader, click "Adobe Acrobat Reader 9.3" on the main menu.

1. Click Next to install or click Change Destination Folder to select another folder.

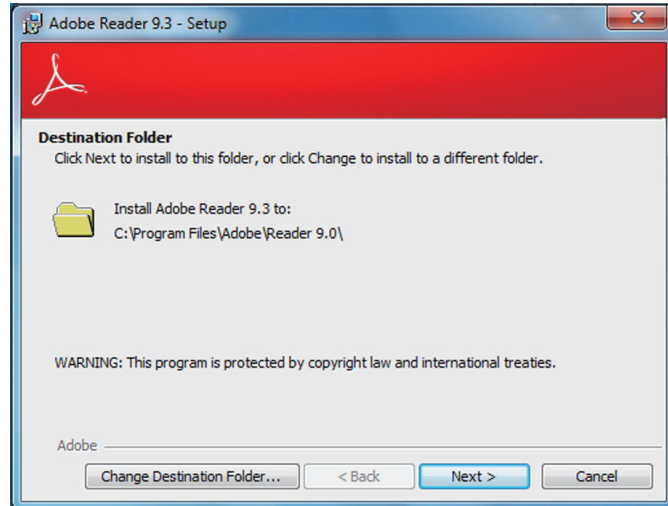

2. Click Install to begin installation.

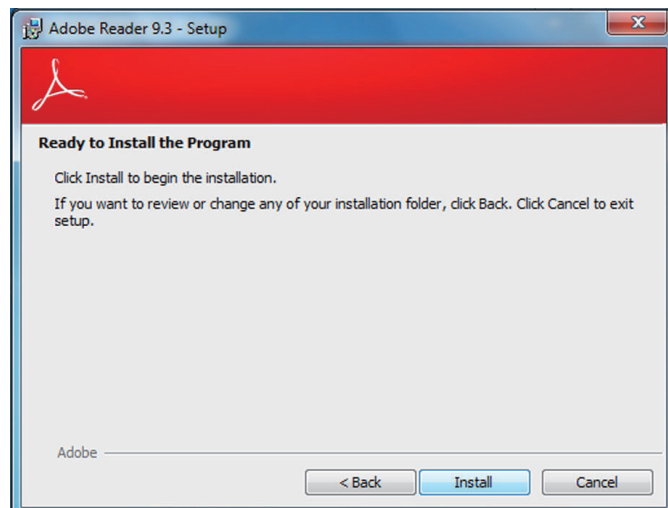

3. Click Finish to exit installation.

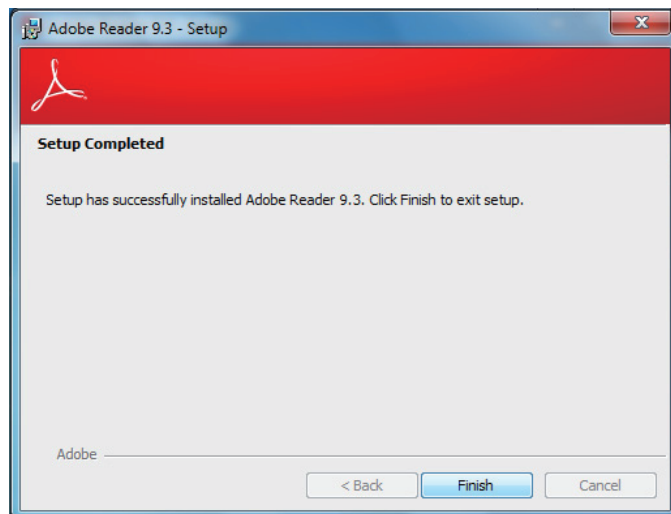

Infineon TPM Driver and Tool (optional)

To install the driver, click "Infineon TPM Driver and Tool" on the main menu.

1. TPM requires installing the Microsoft Visual C++ package prior to installing the driver. Click Install.

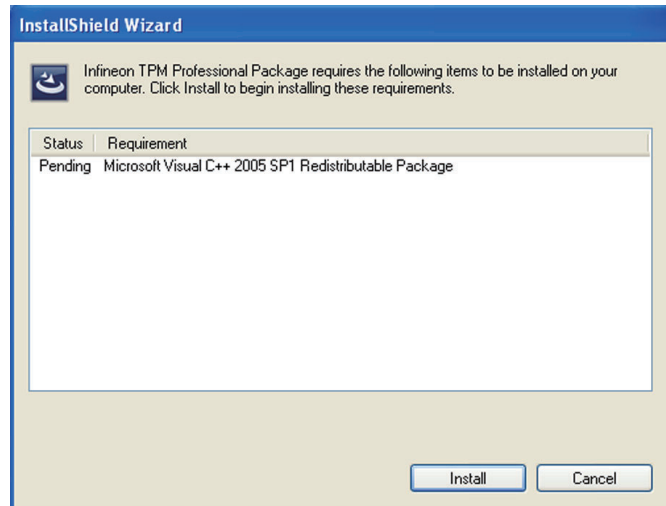

2. The setup program is preparing to install the driver.

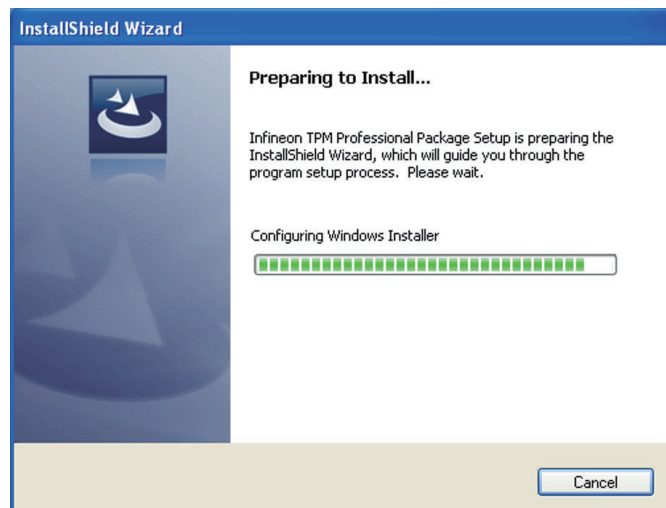

- The setup program is ready to install the driver. Click Next.

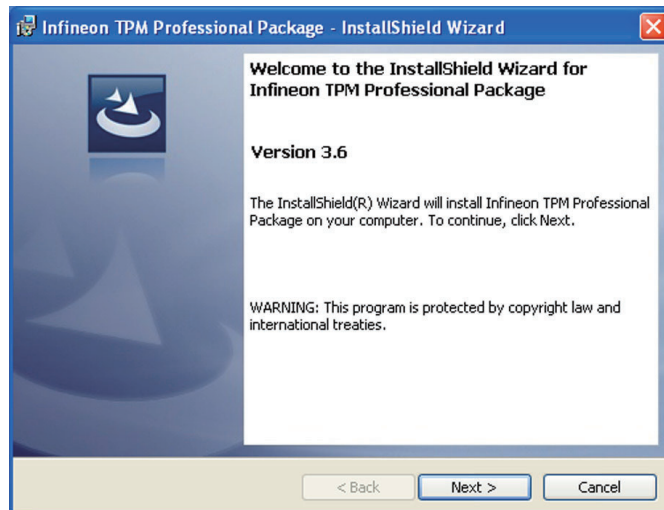

- Click "I accept the terms in the license agreement" and then click "Next".

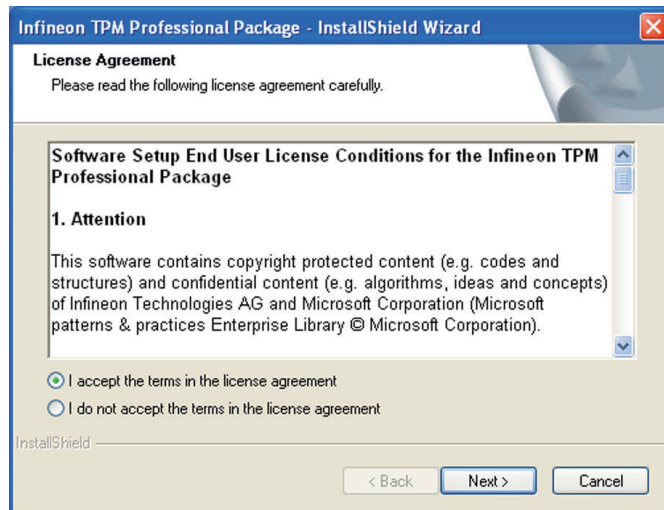

5. Enter the necessary information and then click Next.

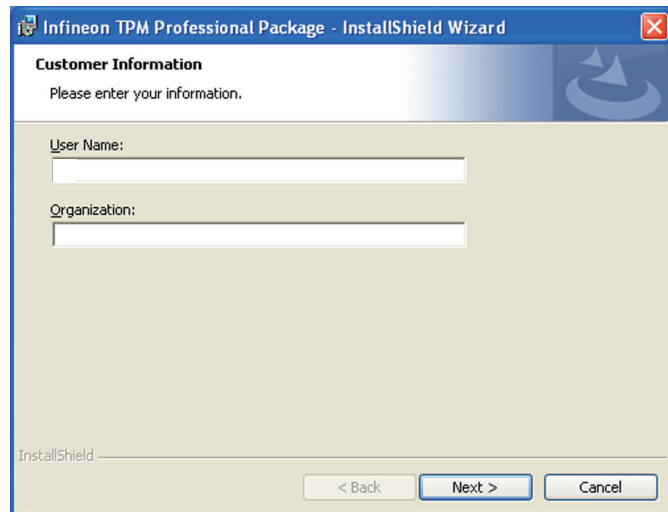

Infineon TPM Professional Package - InstallShield Wizard

Customer Information
Please enter your information.

User Name:

Organization:

InstallShield

< Back Next > Cancel

6. Select a setup type and then click Next.

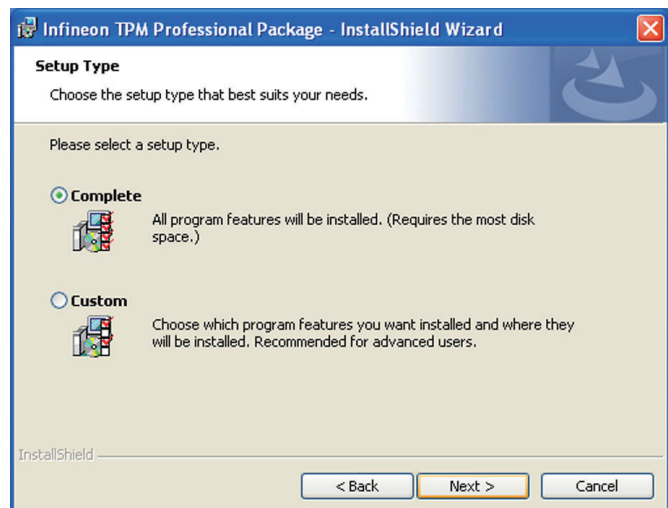

Infineon TPM Professional Package - InstallShield Wizard

Setup Type
Choose the setup type that best suits your needs.

Please select a setup type.

Complete
 All program features will be installed. (Requires the most disk space.)

Custom
 Choose which program features you want installed and where they will be installed. Recommended for advanced users.

InstallShield

< Back Next > Cancel

7. Click Install.

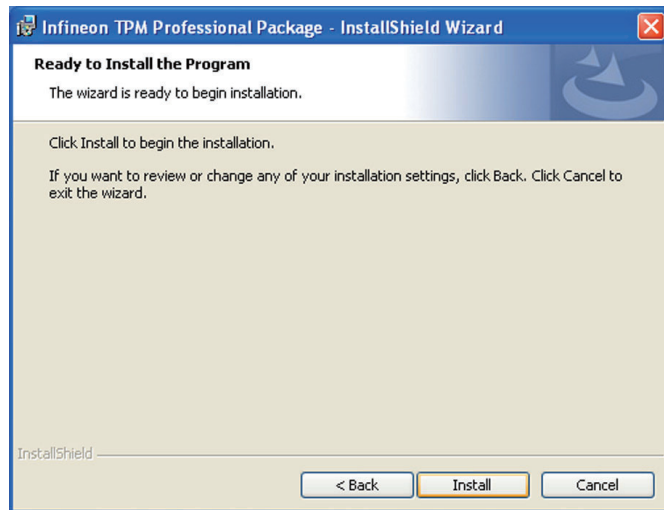

8. The setup program is currently installing the driver.

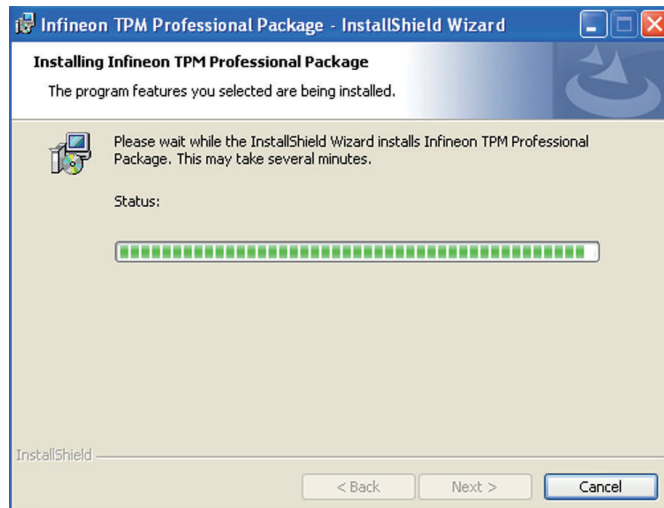

9. Click Finish.

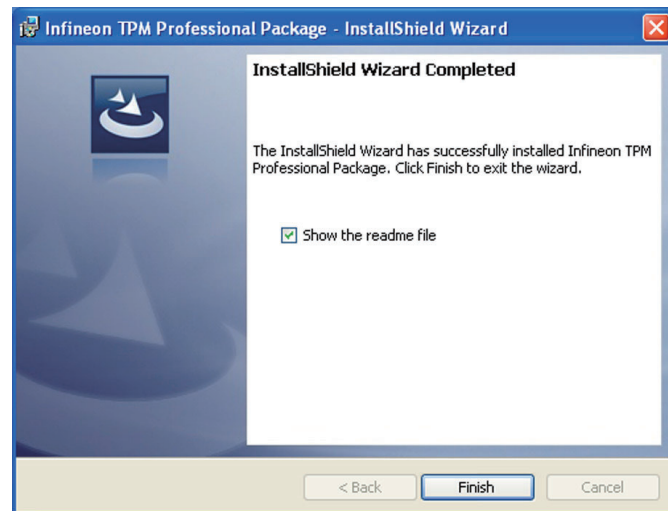

10. Click Yes to restart the system.

Restarting the system will allow the new software installation to take effect.

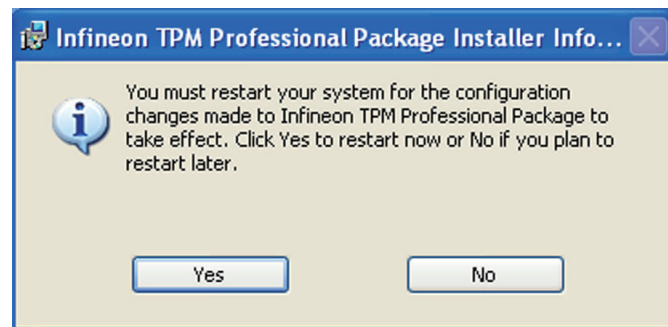

Chapter 5 - RAID

The system board allows configuring RAID on Serial ATA drives. It supports RAID 0, RAID 1, RAID 5 and RAID 10.

RAID Levels

RAID 0 (Striped Disk Array without Fault Tolerance)

RAID 0 uses two new identical hard disk drives to read and write data in parallel, interleaved stacks. Data is divided into stripes and each stripe is written alternately between two disk drives. This improves the I/O performance of the drives at different channel; however it is not fault tolerant. A failed disk will result in data loss in the disk array.

RAID 1 (Mirroring Disk Array with Fault Tolerance)

RAID 1 copies and maintains an identical image of the data from one drive to the other drive. If a drive fails to function, the disk array management software directs all applications to the other drive since it contains a complete copy of the drive's data. This enhances data protection and increases fault tolerance to the entire system. Use two new drives or an existing drive and a new drive but the size of the new drive must be the same or larger than the existing drive.

RAID 5

RAID 5 stripes data and parity information across hard drives. It is fault tolerant and provides better hard drive performance and more storage capacity.

RAID 10 (Mirroring and Striping)

RAID 10 is a combination of data striping and data mirroring providing the benefits of both RAID 0 and RAID 1. Use four new drives or an existing drive and three new drives for this configuration.

Settings

To enable the RAID function, the following settings are required.

1. Connect the Serial ATA drives.
2. Configure Serial ATA in the AMI BIOS.
3. Configure RAID in the RAID BIOS.
4. Install the RAID driver during OS installation.
5. Install the Intel Rapid Storage Drivers.

Step 1: Connect the Serial ATA Drives

Refer to chapter 2 for details on connecting the Serial ATA drives.



Important:

1. Make sure you have installed the Serial ATA drives and connected the data cables otherwise you won't be able to enter the RAID BIOS utility.
2. Treat the cables with extreme caution especially while creating RAID. A damaged cable will ruin the entire installation process and operating system. The system will not boot and you will lose all data in the hard drives. Please give special attention to this warning because there is no way of recovering back the data.

Step 2: Configure Serial ATA in the AMI BIOS

1. Power-on the system then press to enter the main menu of the AMI BIOS.
2. Configure Serial ATA in the appropriate fields.
3. Save the changes in the Save & Exit menu.
4. Reboot the system.

Step 3: Configure RAID in the RAID BIOS

When the system powers-up and all drives have been detected, the Intel RAID BIOS status message screen will appear. Press the <Ctrl> and <I> keys simultaneously to enter the utility. The utility allows you to build a RAID system on Serial ATA drives.

Step 4: Install the RAID Driver During OS Installation

The RAID driver must be installed during the Windows® XP or Windows® 2000 installation using the F6 installation method. This is required in order to install the operating system onto a hard drive or RAID volume when in RAID mode or onto a hard drive when in AHCI mode.

1. Start Windows Setup by booting from the installation CD.
2. Press <F6> when prompted in the status line with the 'Press F6 if you need to install a third party SCSI or RAID driver' message.
3. Press <S> to "Specify Additional Device".
4. At this point you will be prompted to insert a floppy disk containing the RAID driver. Insert the RAID driver diskette.
5. Locate for the drive where you inserted the diskette then select RAID or AHCI controller that corresponds to your BIOS setup. Press <Enter> to confirm.

You have successfully installed the driver. However you must continue installing the OS. Leave the floppy disk in the floppy drive until the system reboots itself because Windows setup will need to copy the files again from the floppy disk to the Windows installation folders. After Windows setup has copied these files again, remove the floppy diskette so that Windows setup can reboot as needed.

Step 5: Install the Intel Rapid Storage Drivers

The Intel Rapid Storage Drivers can be installed from within Windows. It allows RAID volume management (create, delete, migrate) from within the operating system. It will also display useful SATA device and RAID volume information. The user interface, tray icon service and monitor service allow you to monitor the current status of the RAID volume and/or SATA drives. It enables enhanced performance and power management for the storage subsystem.

1. Insert the provided CD into an optical drive.
2. Click "Intel Rapid Storage Technology for Raid/AHCI" on the main menu.
3. Setup is ready to install the utility. Click Next.



4. Read the warning carefully then click Next.



5. Read the license agreement then click Yes.



6. Go through the readme document to view system requirements and installation information then click Next.



7. Setup is currently installing the driver. After installation has completed, click Next.

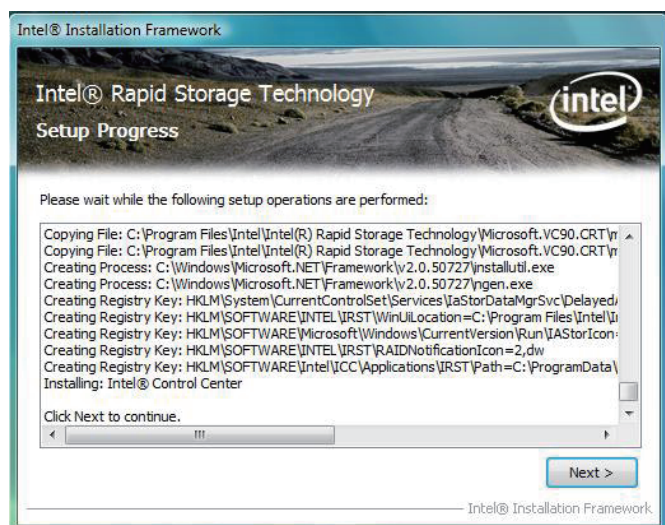

8. Click "Yes, I want to restart my computer now" then click Finish.



Chapter 6 - Intel AMT Settings

Overview

Intel Active Management Technology (Intel® AMT) combines hardware and software solution to provide maximum system defense and protection to networked systems.

The hardware and software information are stored in non-volatile memory. With its built-in manageability and latest security applications, Intel® AMT provides the following functions.

- Discover

Allows remote access and management of networked systems even while PCs are powered off; significantly reducing desk-side visits.

- Repair

Remotely repair systems after OS failures. Alerting and event logging help detect problems quickly to reduce downtime.

- Protect

Intel AMT's System Defense capability remotely updates all systems with the latest security software. It protects the network from threats at the source by proactively blocking incoming threats, reactively containing infected clients before they impact the network, and proactively alerting when critical software agents are removed.

Enable Intel® AMT in the AMI BIOS

1. Power-on the system then press to enter the main menu of the AMI BIOS.
2. In the **Advanced** menu, select **AMT Configuration**.

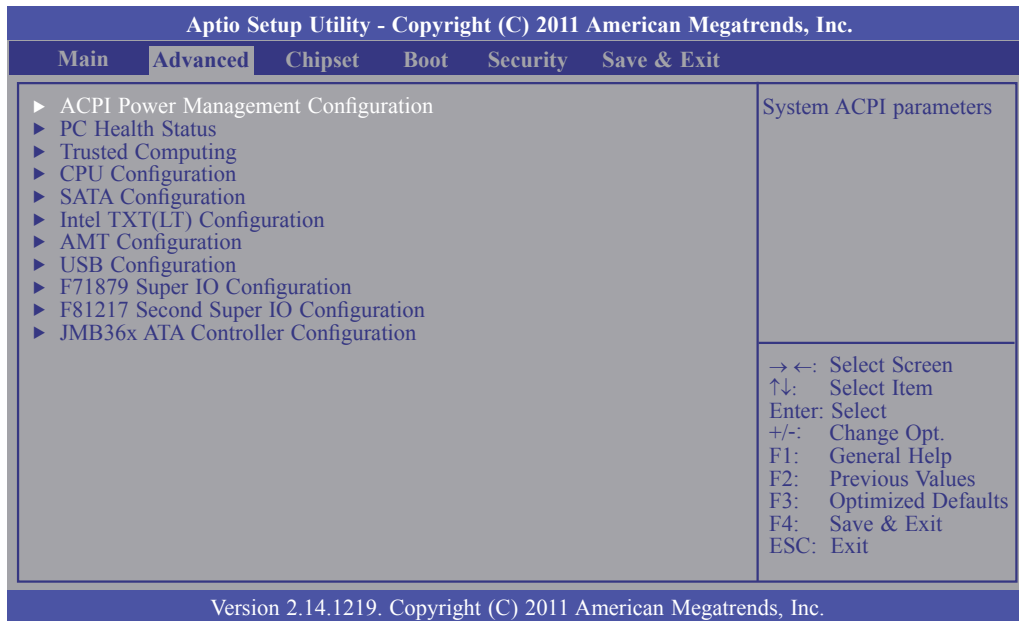

3. In the **Advanced** menu, select **Enable** in the **AMT** field.

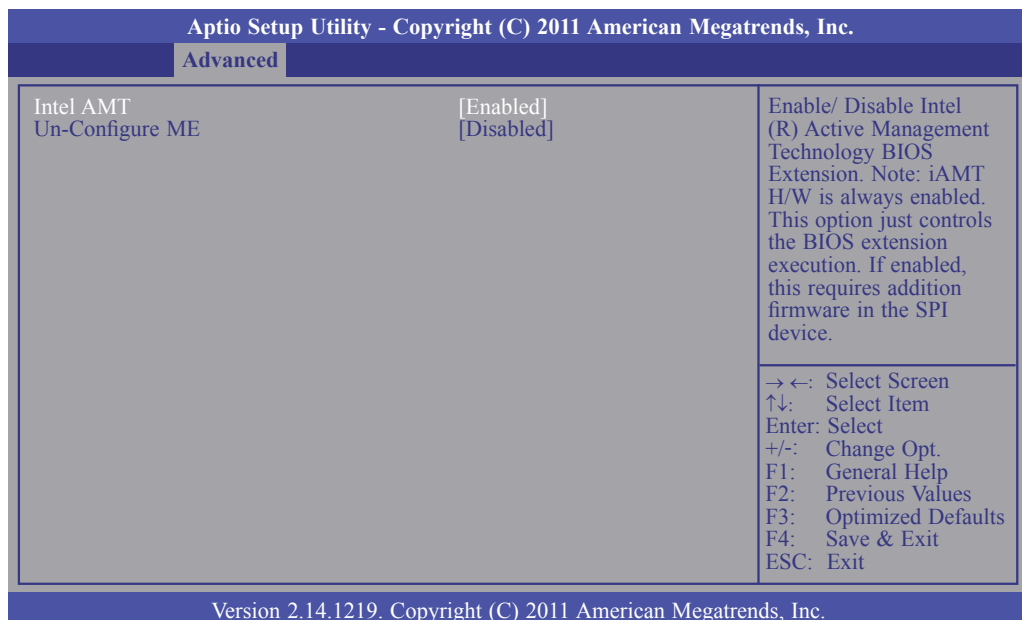

4. In the **Save & Exit** menu, select **Save Changes and Reset** then select **OK**.

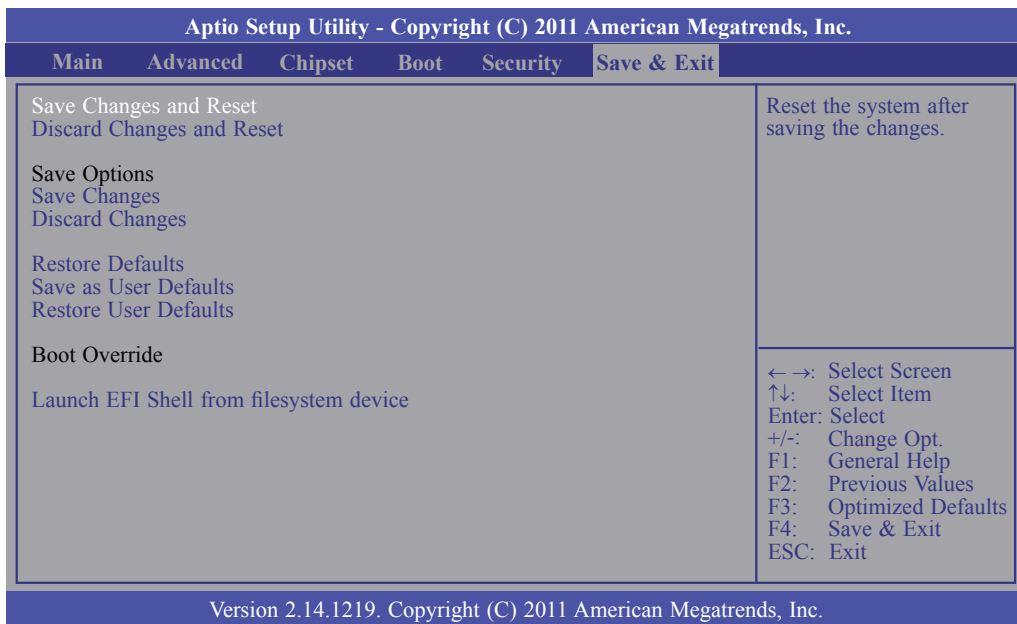

Enable Intel® AMT in the Intel® Management Engine BIOS Extension (MEBX) Screen

1. When the system reboots, the following message will be displayed. Press **<Ctrl-P>** as soon as the message is displayed; as this message will be displayed for only a few seconds.

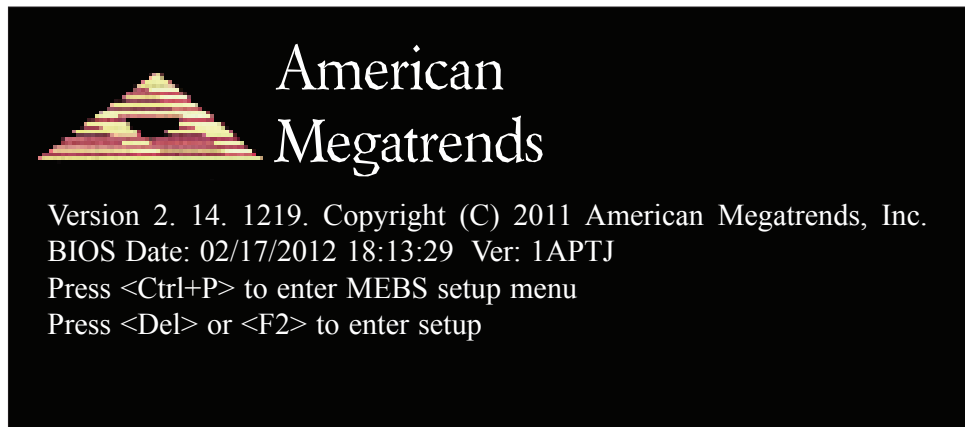

2. You will be prompted for a password. The default password is "**admin**". Enter the default password in the space provided under Intel(R) ME Password then press Enter.

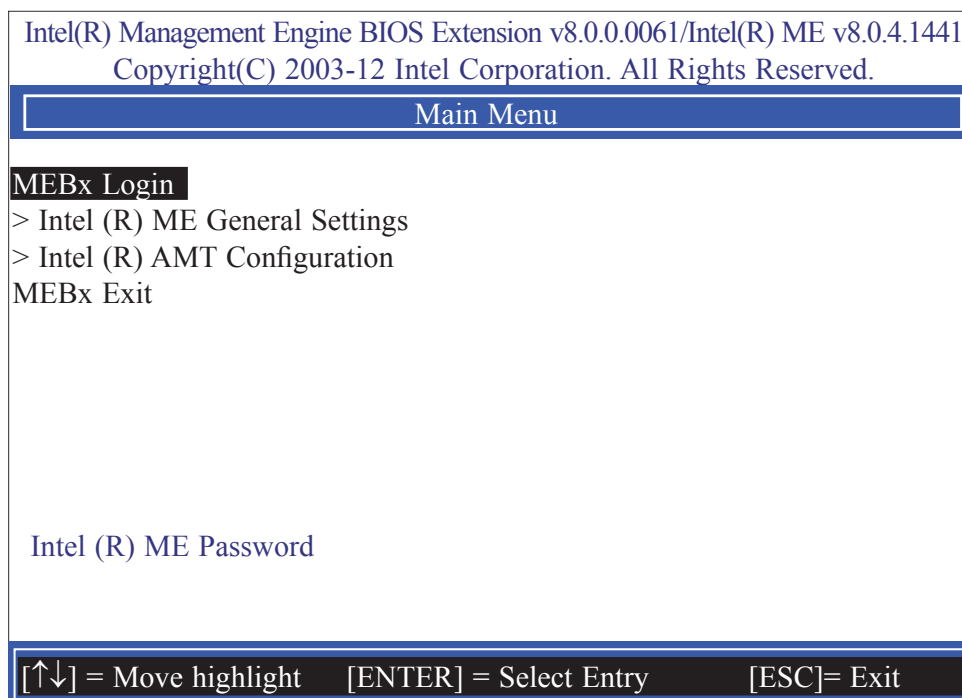

3. Enter a new password in the space provided under Intel(R) ME New Password then press Enter. The password must include:
- 8-32 characters
 - Strong 7-bit ASCII characters excluding : , and " characters
 - At least one digit character (0, 1, ...9)
 - At least one 7-bit ASCII non alpha-numeric character, above 0x20, (e.g. !, \$, ;)
 - Both lower case and upper case characters

Intel(R) Management Engine BIOS Extension v8.0.0.0061/Intel(R) ME v8.0.4.1441
Copyright(C) 2003-12 Intel Corporation. All Rights Reserved.

Main Menu

MEBx Login

> Intel (R) ME General Settings
> Intel (R) AMT Configuration
MEBx Exit

Intel (R) ME Password

Intel (R) ME Password

[↑↓] = Move highlight [ENTER] = Select Entry [ESC]= Exit

- You will be asked to verify the password. Enter the same new password in the space provided under Verify Password then press Enter.

Intel(R) Management Engine BIOS Extension v8.0.0.0061/Intel(R) ME v8.0.4.1441
Copyright(C) 2003-12 Intel Corporation. All Rights Reserved.

Main Menu

MEBx Login

- > Intel (R) ME General Settings
- > Intel (R) AMT Configuration
- MEBx Exit

Verify Password

Intel (R) ME Password

[↑↓] = Move highlight [ENTER] = Select Entry [ESC]= Exit

- Select **Intel(R) ME General Settings** then press Enter.

Intel(R) Management Engine BIOS Extension v8.0.0.0061/Intel(R) ME v8.0.4.1441
Copyright(C) 2003-12 Intel Corporation. All Rights Reserved.

Main Menu

- > Intel (R) ME General Settings**
- > Intel (R) AMT Configuration
- MEBx Exit

[↑↓] = Move highlight [ENTER] = Select Entry [ESC]= Exit

6. Select **Change Intel(R) ME Password** then press Enter.

You will be prompted for a password. The default password is "**admin**". Enter the default password in the space provided under Intel(R) ME New Password then press Enter.

- 8-32 characters
- Strong 7-bit ASCII characters excluding : , and " characters
- At least one digit character (0, 1, ...9)
- At least one 7-bit ASCII non alpha-numeric character, above 0x20, (e.g. !, \$, ;)
- Both lower case and upper case characters

Intel(R) Management Engine BIOS Extension v8.0.0.0061/Intel(R) ME v8.0.4.1441
Copyright(C) 2003-12 Intel Corporation. All Rights Reserved.

INTEL (R) ME PLATFORM CONFIGURATION

> **Change ME Password**
Local FW Updtate <Enabled>
> Power Control

Intel (R) ME New Password

[↑↓] = Move highlight [ENTER] = Select Entry [ESC]= Exit

7. Select **Local FW Update** then press Enter. Select **Enabled** then press Enter.

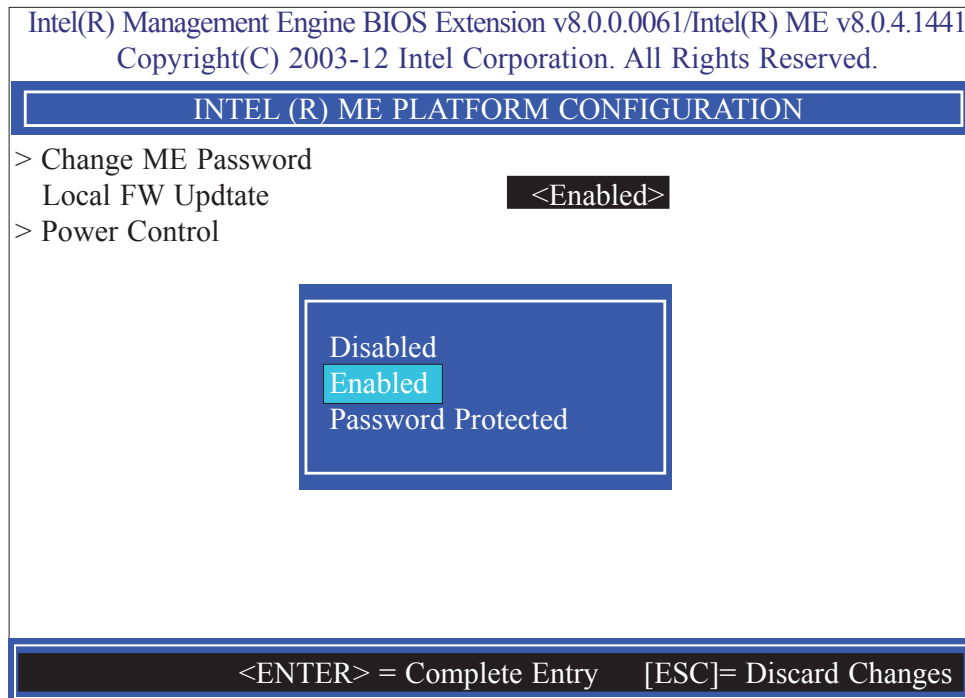

8. In the **Intel(R) ME Platform Configuration** menu, select **Power Control** then press Enter.

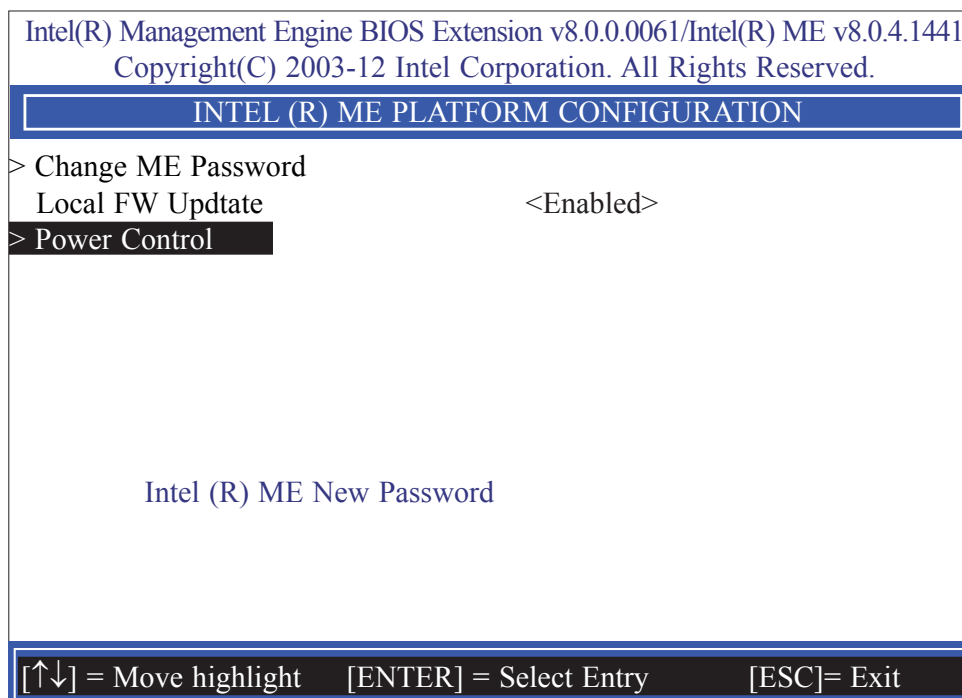

9. In the **Intel(R) ME Power Control** menu, select **Intel(R) ME ON in Host Sleep States** then press Enter. Select an option then press Enter.

Intel(R) Management Engine BIOS Extension v8.0.0.0061/Intel(R) ME v8.0.4.1441
Copyright(C) 2003-12 Intel Corporation. All Rights Reserved.

INTEL (R) ME POWER CONTROL

Intel (R) ME ON in Host Sleep States <Desktop: ON in S0>
Idle Timeout 1

Desktop: ON in S0
Desktop: ON in S0, ME Wake in S3, S4-5

[↑↓] = Move highlight [ENTER] = Select Entry [ESC]= Discard changes

10. In the **Intel(R) ME Power Control** menu, select **Idle Timeout** then press Enter. Enter the timeout value.

Intel(R) Management Engine BIOS Extension v8.0.0.0061/Intel(R) ME v8.0.4.1441
Copyright(C) 2003-12 Intel Corporation. All Rights Reserved.

INTEL (R) ME POWER CONTROL

Intel (R) ME ON in Host Sleep States <Desttop ON in S0>
Idle Timeout 1

Timeout Value (1-65535)

1_

<ENTER> = Complete Entry [ESC]= Discard Changes

11. Select Previous Menu until you return to the **Main Menu**. Select **Intel(R) AMT Configuration** then press Enter.

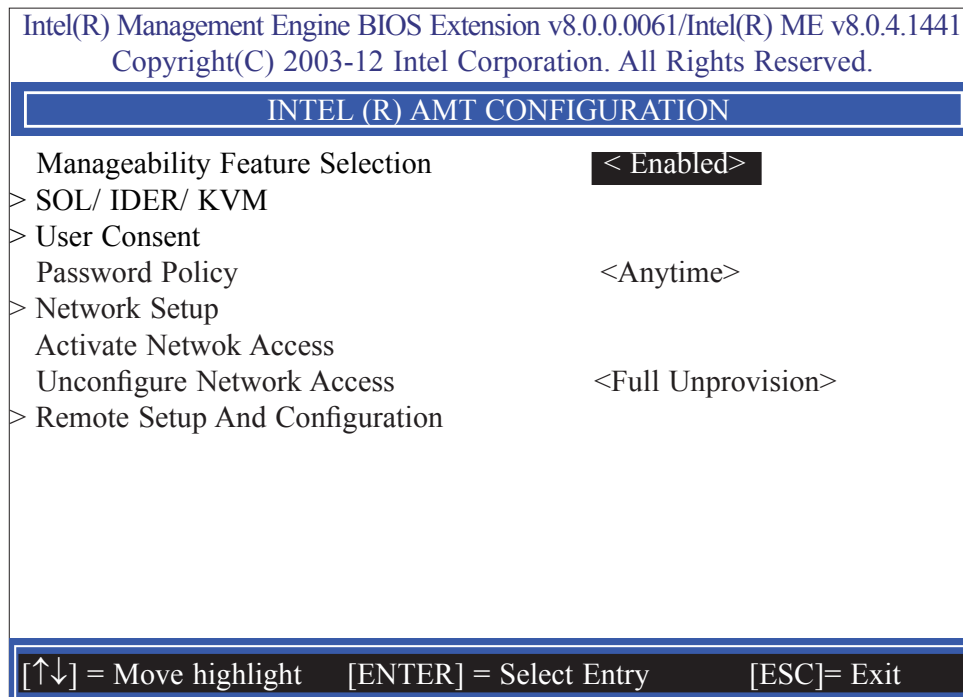

12. In the **Intel(R) AMT Configuration** menu, select **Manageability Feature Selection** then press Enter. Select disabled then press Enter.

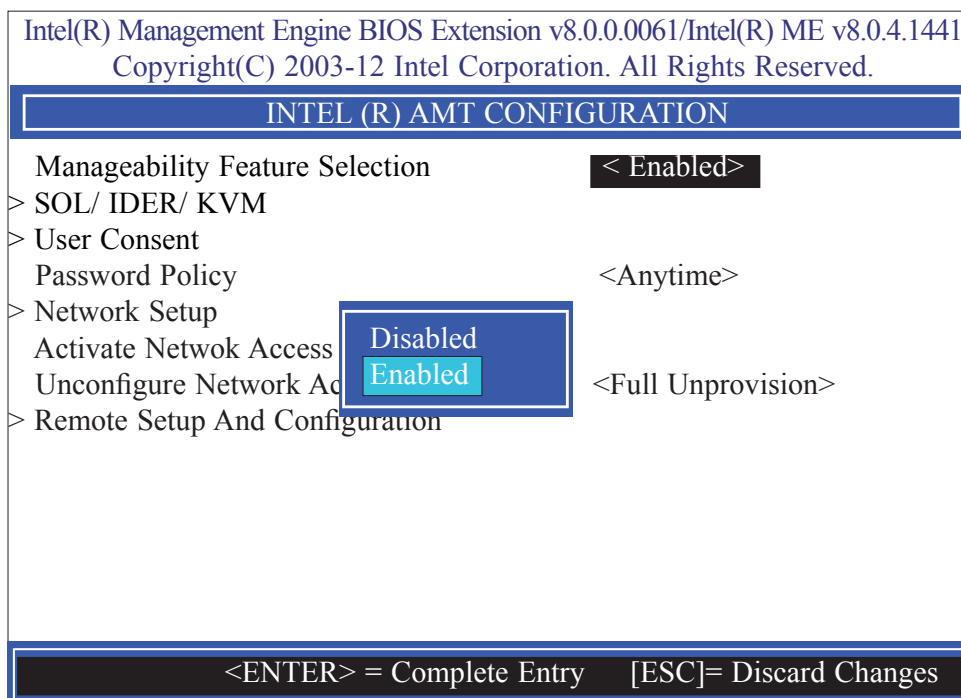

13. In the **Intel(R) AMT Configuration** menu, select **SOL/IDER/KVM** then press Enter.

Intel(R) Management Engine BIOS Extension v8.0.0.0061/Intel(R) ME v8.0.4.1441
Copyright(C) 2003-12 Intel Corporation. All Rights Reserved.

SOL/ IDER/ KVM

Username and password	< Enabled >
SOL	<Enabled>
IDER	<Enabled>
KVM Feature Selection	<Enabled>
Legacy Redirection Mode	<Disabled>

Menu for FW Redirection Configuration

[↑↓] = Move highlight [ENTER] = Select Entry [ESC]= Exit

14. In the **SOL/IDER/KVM** menu, select **Username and Password** then press Enter. Select disabled then press Enter.

Intel(R) Management Engine BIOS Extension v8.0.0.0061/Intel(R) ME v8.0.4.1441
Copyright(C) 2003-12 Intel Corporation. All Rights Reserved.

SOL/ IDER/ KVM

Username and password	< Enabled >
SOL	<Enabled>
IDER	<Enabled>
KVM Feature Selection	<Enabled>
Legacy Redirection Mode	<Disabled>

Disabled

Enabled

<ENTER> = Complete Entry [ESC]= Discard Changes

15. In the **SOL/IDER/KVM** menu, select **SOL** then press Enter. Select disabled then press Enter.

Intel(R) Management Engine BIOS Extension v8.0.0.0061/Intel(R) ME v8.0.4.1441
Copyright(C) 2003-12 Intel Corporation. All Rights Reserved.

SOL/ IDER/ KVM

Username and password	< Enabled>
SOL	<Enabled>
IDER	<Enabled>
KVM Feature Selection	<Enabled>
Legacy Redirection Mode	<Disabled>

Disabled
Enabled

<ENTER> = Complete Entry [ESC]= Discard Changes

16. In the **SOL/IDER/KVM** menu, select **IDER** then press Enter. Select disabled then press Enter.

Intel(R) Management Engine BIOS Extension v8.0.0.0061/Intel(R) ME v8.0.4.1441
Copyright(C) 2003-12 Intel Corporation. All Rights Reserved.

SOL/ IDER/ KVM

Username and password	< Enabled>
SOL	<Enabled>
IDER	<Enabled>
KVM Feature Selection	<Enabled>
Legacy Redirection Mode	<Disabled>

Disabled
Enabled

<ENTER> = Complete Entry [ESC]= Discard Changes

17. In the **SOL/IDER/KVM** menu, select **KVM** then press Enter. Select disabled then press Enter.

Intel(R) Management Engine BIOS Extension v8.0.0.0061/Intel(R) ME v8.0.4.1441
Copyright(C) 2003-12 Intel Corporation. All Rights Reserved.

SOL/ IDER/ KVM

Username and password	< Enabled>
SOL	<Enabled>
IDER	<Enabled>
KVM Feature Selection	<Enabled>
Legacy Redirection Mode	<Disabled>

Disabled
Enabled

<ENTER> = Complete Entry [ESC]= Discard Changes

18. In the **SOL/IDER/KVM** menu, select **Legacy Redirection Mode** then press Enter.

Intel(R) Management Engine BIOS Extension v8.0.0.0061/Intel(R) ME v8.0.4.1441
Copyright(C) 2003-12 Intel Corporation. All Rights Reserved.

SOL/ IDER/ KVM

Username and password	< Enabled>
SOL	<Enabled>
IDER	<Enabled>
KVM Feature Selection	<Enabled>
Legacy Redirection Mode	<Disabled>

Menu for FW Redirection Configuration

[↑↓] = Move highlight [ENTER] = Select Entry [ESC]= Exit

19. Select Enabled then press Enter.

Intel(R) Management Engine BIOS Extension v8.0.0.0061/Intel(R) ME v8.0.4.1441
Copyright(C) 2003-12 Intel Corporation. All Rights Reserved.

SOL/ IDER/ KVM

Username and password	< Enabled>
SOL	<Enabled>
IDER	<Enabled>
KVM Feature Selection	<Enabled>
Legacy Redirection Mode	<Disabled>

Disabled
 Enabled

<ENTER> = Complete Entry [ESC]= Discard Changes

20. Select Previous Menu until you return to the **Intel(R) AMT Configuration** menu. Select **User Consent** then press Enter.

Intel(R) Management Engine BIOS Extension v8.0.0.0061/Intel(R) ME v8.0.4.1441
Copyright(C) 2003-12 Intel Corporation. All Rights Reserved.

USER CONSENT

User Opt-in	< KVM>
Opt-in Configuration from Remote IT	< Enabled>

Configure when user consent should be required.

[↑↓] = Move highlight [ENTER] = Select Entry [ESC]= Exit

21. In the **User Consent Configuration** menu, select **User Opt-in** then press Enter. Select **None** then press Enter.

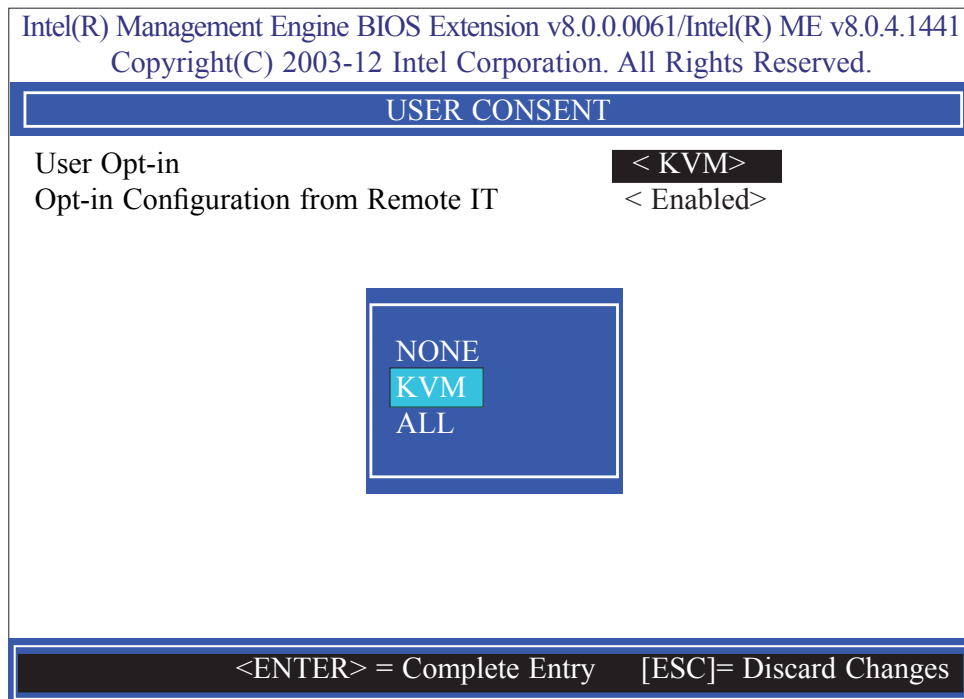

22. In the **User Consent Configuration** menu, select **Opt-in Configurable from Remote IT** then press Enter. Select **Disable Remote Control of KVM Opt-in Policy** then press Enter.

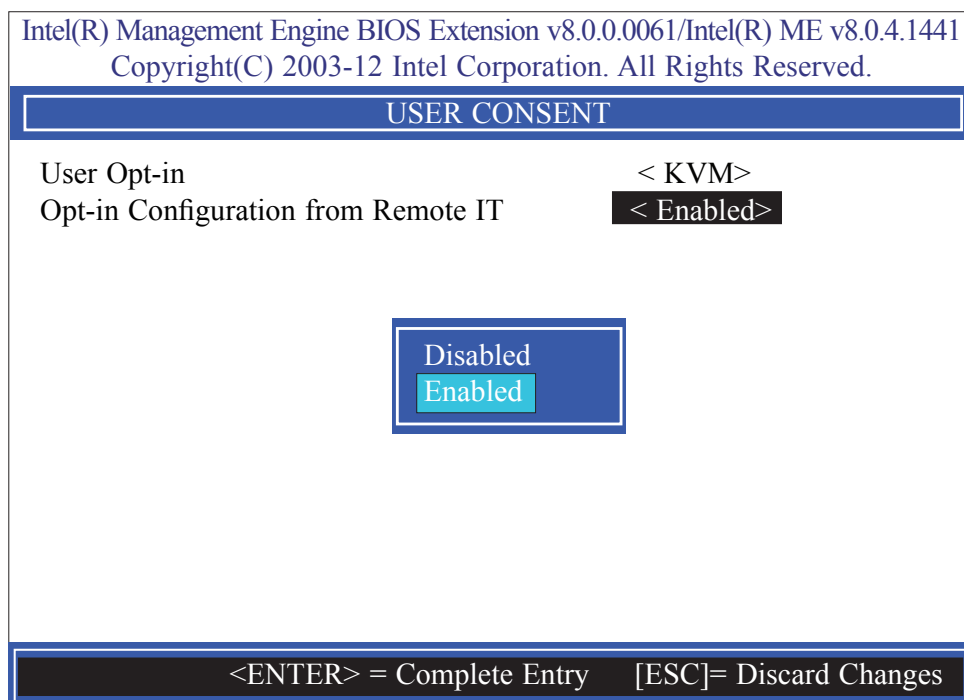

23. Select Previous Menu until you return to the **Intel(R) AMT Configuration** menu. Select **Password Policy** then press Enter.

You may choose to use a password only during setup and configuration or to use a password anytime the system is being accessed.

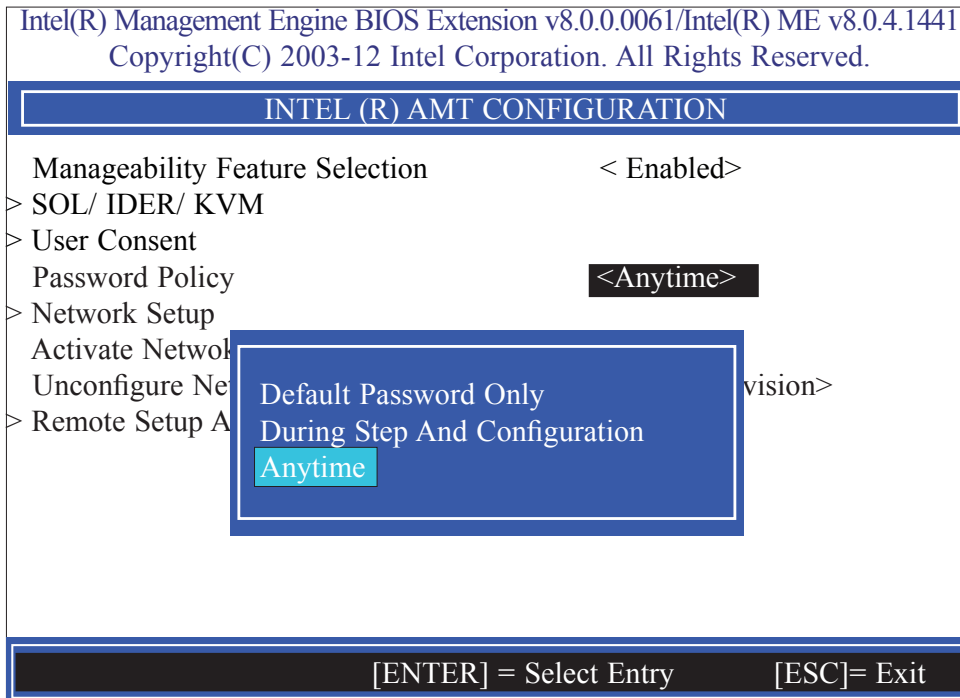

24. In the **Intel(R) AMT Configuration** menu, select **Network Setup** then press Enter.

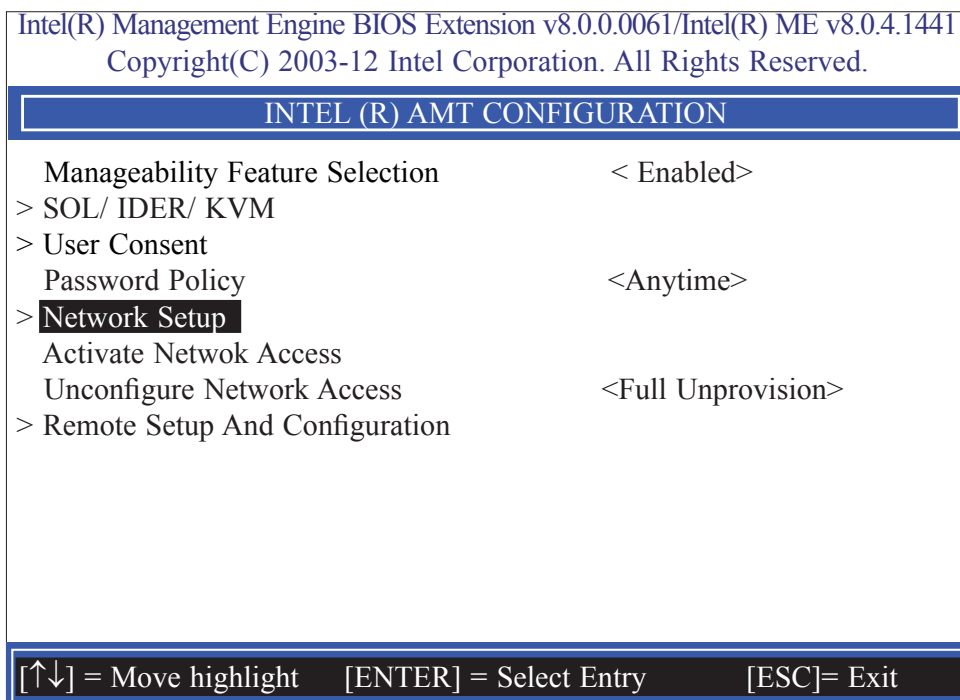

25. In the **Intel(R) Network Setup** menu, select **Intel(R) ME Network Name Settings** then press Enter.

Intel(R) Management Engine BIOS Extension v8.0.0.0061/Intel(R) ME v8.0.4.1441
Copyright(C) 2003-12 Intel Corporation. All Rights Reserved.

INTEL (R) ME NETWORK SETUP

> Intel (R) ME Network Name Settings
> TCP/ IP Settings

[↑↓] = Move highlight [ENTER] = Select Entry [ESC]= Exit

26. In the **Intel(R) ME Network Name Settings** menu, select **Host Name** then press Enter. Enter the computer's host name then press Enter.

Intel(R) Management Engine BIOS Extension v8.0.0.0061/Intel(R) ME v8.0.4.1441
Copyright(C) 2003-12 Intel Corporation. All Rights Reserved.

INTEL (R) ME NETWORK NAME SETTINGS

Host Name ─
Domain Name ─
Shared/ Dedicated FQDN <Shared>
Dynamic DNS Update <Disabled>

Computer Host Name

<ENTER> = Complete Entry [ESC]= Discard Changes

27. Select **Domain Name** then press Enter. Enter the computer's domain name then press Enter.

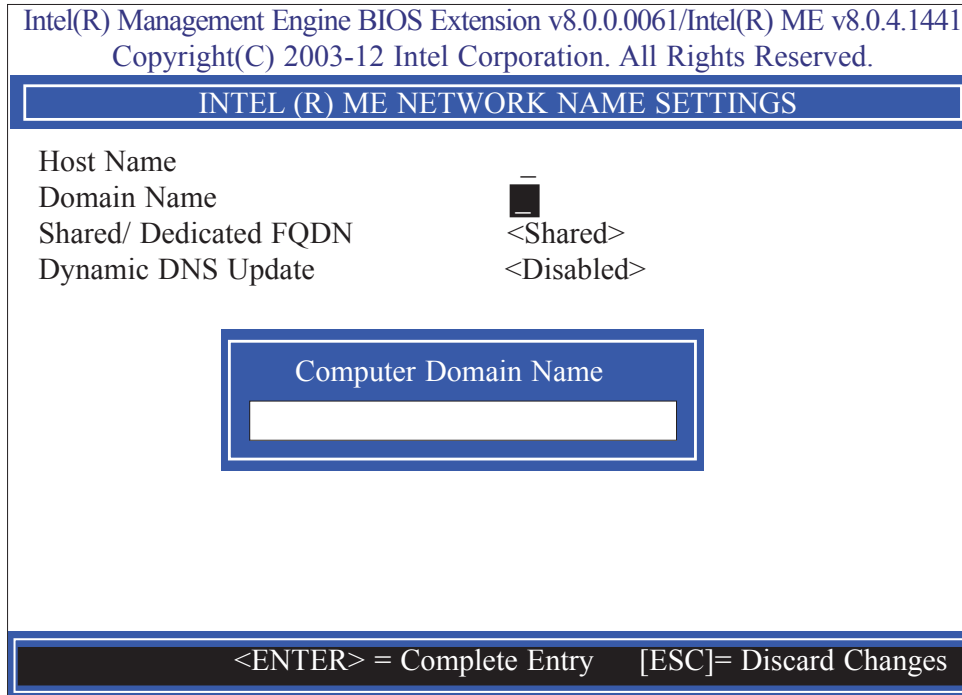

28. Select **Shared/Dedicated FQDN** then press Enter. Select Shared or Dedicated then press Enter.

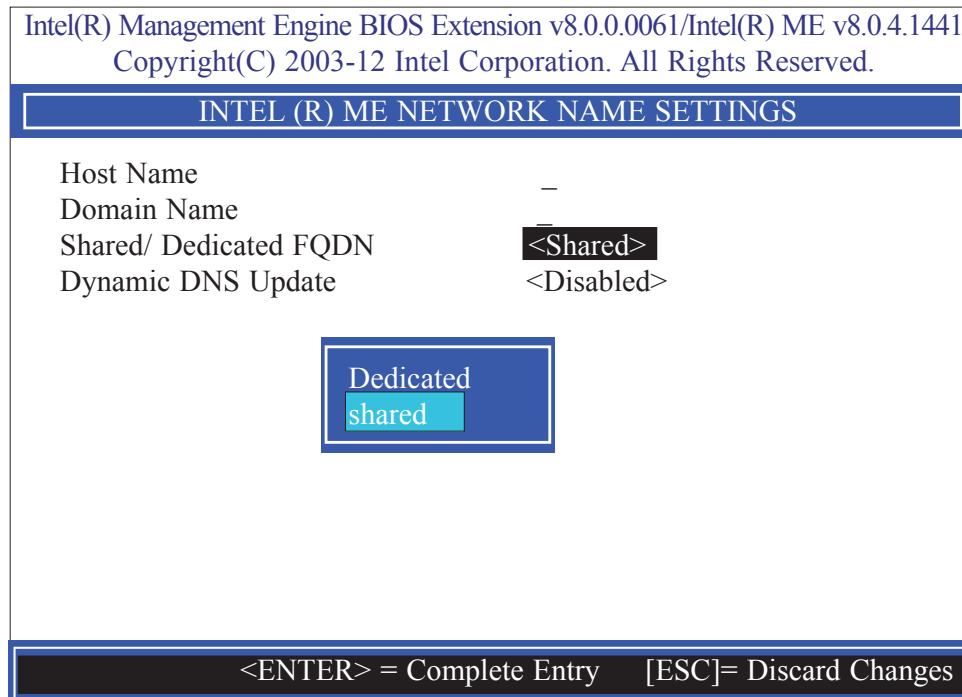

29. Select **Dynamic DNS Update** then press Enter. Select Enabled or Disabled then press Enter.

Intel(R) Management Engine BIOS Extension v8.0.0.0061/Intel(R) ME v8.0.4.1441
Copyright(C) 2003-12 Intel Corporation. All Rights Reserved.

INTEL (R) ME NETWORK NAME SETTINGS

Host Name	-
Domain Name	-
Shared/ Dedicated FQDN	<Shared>
Dynamic DNS Update	<Disabled>

Disabled
Enabled

<ENTER> = Complete Entry [ESC]= Discard Changes

30. Select Previous Menu until you return to the **Intel(R) ME Network Setup** menu. Select **TCP/IP Settings** then press Enter.

Intel(R) Management Engine BIOS Extension v8.0.0.0061/Intel(R) ME v8.0.4.1441
Copyright(C) 2003-12 Intel Corporation. All Rights Reserved.

TCP/ IP SETTINGS

> Wired LAN IPV4 Configuration

[↑↓] = Move highlight [ENTER] = Select Entry [ESC]= Exit

31. In the **TCP/IP Settings** menu, select **Wired LAN IPV4 Configuration** then press Enter.

Intel(R) Management Engine BIOS Extension v8.0.0.0061/Intel(R) ME v8.0.4.1441
Copyright(C) 2003-12 Intel Corporation. All Rights Reserved.

WIRED LAN IPV4 CONFIGURATION

DHCP Mode <Enabled>

Disabled
Enabled

<ENTER> = Complete Entry [ESC]= Discard Changes

32. Select Previous Menu until you return to the **Intel(R) AMT Configuration** menu. Select **Activate Network Access** then press Enter. Type **Y** then press Enter.

Intel(R) Management Engine BIOS Extension v8.0.0.0061/Intel(R) ME v8.0.4.1441
Copyright(C) 2003-12 Intel Corporation. All Rights Reserved.

INTEL (R) AMT CONFIGURATION

Manageability Feature Selection < Enabled>

> SOL/ IDER/ KVM

> User Consent

 Password Policy <Anytime>

> Network Setup

Activate Network Access

 Unconfigure Network on>

> Remote Setup And

Activates the current network settings
 and opens the ME network interface
 Continue: (Y/N)

[↑↓] = Move highlight [ENTER] = Select Entry [ESC]= Exit

33. In the **Intel(R) AMT Configuration** menu, select **Unconfigure Network Access** then press Enter. Type **Y** then press Enter.



34. In the **Intel(R) AMT Configuration** menu, select **Remote Setup And Configuration** then press Enter.

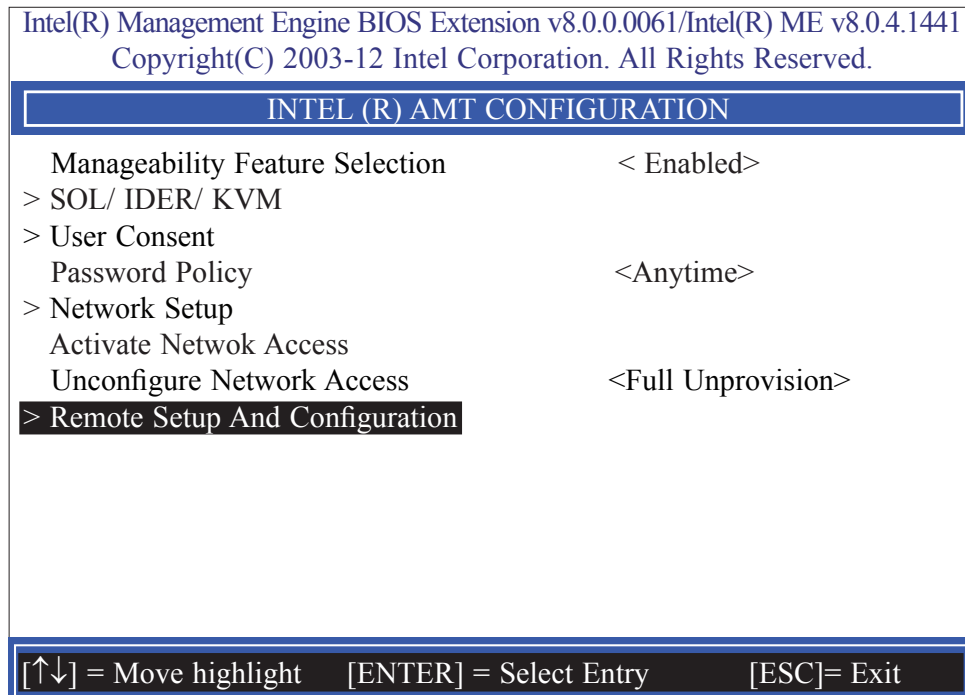

35. In the **Intel(R) Automated Setup And Configuration** menu, select **Current Provisioning Mode** then press Enter.

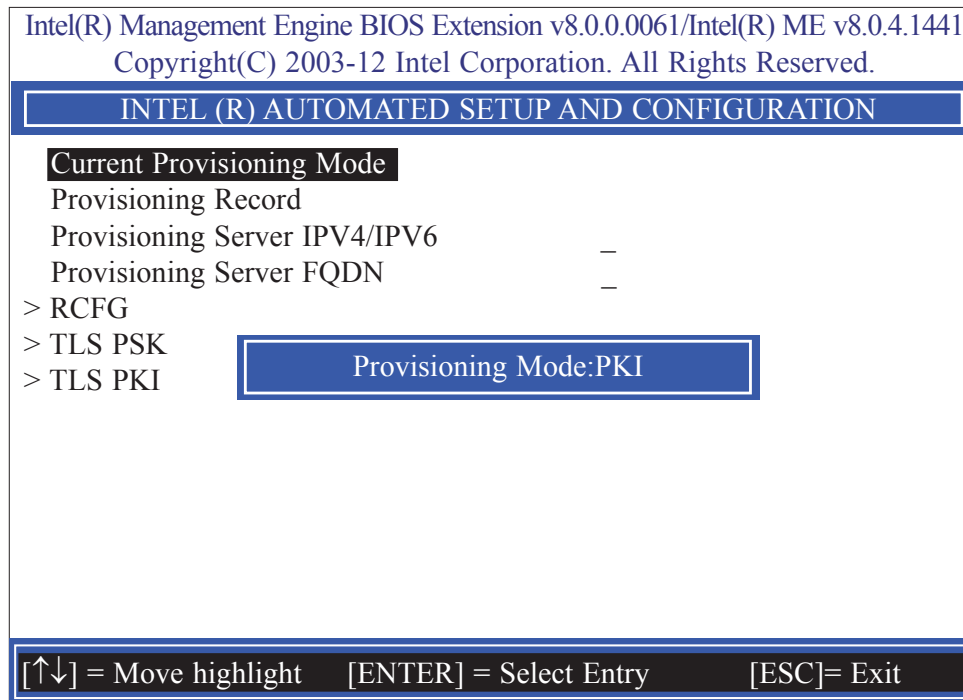

36. In the **Intel(R) Automated Setup And Configuration** menu, select **Provisioning Record** then press Enter.

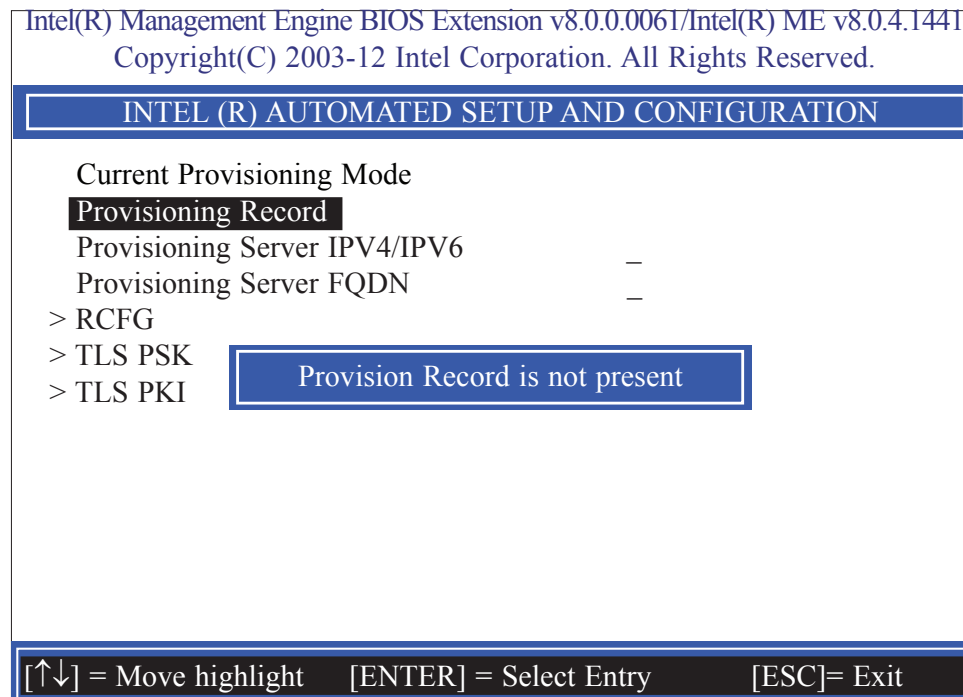

37. Select Previous Menu until you return to the **Intel(R) Automated Setup And Configuration** menu. Select **Provisioning Server IPV4/IPV6** then press Enter. Type server address then press Enter.

Intel(R) Management Engine BIOS Extension v8.0.0.0061/Intel(R) ME v8.0.4.1441
Copyright(C) 2003-12 Intel Corporation. All Rights Reserved.

INTEL (R) AUTOMATED SETUP AND CONFIGURATION

Current Provisioning Mode
Provisioning Record
Provisioning Server IPV4/IPV6
Provisioning Server FQDN
> RCFG
> TLS PSK
> TLS PKI

Provisioning server address

<ENTER> = Complete Entry [ESC]= Discard Changes

38. In the **Intel(R) Automated Setup And Configuration** menu, select **Provisioning Server FQDN** then press Enter. Type FQDN of provisioning server then press Enter.

Intel(R) Management Engine BIOS Extension v8.0.0.0061/Intel(R) ME v8.0.4.1441
Copyright(C) 2003-12 Intel Corporation. All Rights Reserved.

INTEL (R) AUTOMATED SETUP AND CONFIGURATION

Current Provisioning Mode
Provisioning Record
Provisioning Server IPV4/IPV6
Provisioning Server FQDN
> RCFG
> TLS PSK
> TLS PKI

Enter FQDN of provisioning server

<ENTER> = Complete Entry [ESC]= Discard Changes

39. In the **Intel(R) Remote Configuration** menu, select **Start Configuration** then press Enter. Type **Y** then press Enter.

Intel(R) Management Engine BIOS Extension v8.0.0.0061/Intel(R) ME v8.0.4.1441
Copyright(C) 2003-12 Intel Corporation. All Rights Reserved.

INTEL (R) REMOTE CONFIGURATION

Start Configuration

This will activate Remote Configuration.
Continue: (Y/N)

[↑↓] = Move highlight [ENTER] = Select Entry [ESC]= Exit

40. In the **Intel(R) Automated Setup And Configuration** menu, select **TLS PSK** then press Enter.

Intel(R) Management Engine BIOS Extension v8.0.0.0061/Intel(R) ME v8.0.4.1441
Copyright(C) 2003-12 Intel Corporation. All Rights Reserved.

INTEL (R) TLS PSK CONFIGURATION

Set PID and PPS **

Delete PID and PPS **

Enter PID (e.g. ABCD-1234)

<ENTER> = Complete Entry [ESC]= Exit

41. In the **Intel(R) Remote Configuration** menu, select **Set PID and PPS **** then press Enter. Type PID code then press Enter.

Intel(R) Management Engine BIOS Extension v8.0.0.0061/Intel(R) ME v8.0.4.1441
Copyright(C) 2003-12 Intel Corporation. All Rights Reserved.

INTEL (R) TLS PSK CONFIGURATION

Set PID and PPS **

Delete PID and PPS **

Enter PID (e.g. ABCD-1234)

<ENTER> = Complete Entry [ESC]= Exit

42. In the **Intel(R) Remote Configuration** menu, select **Delete PID and PPS **** then press Enter. Type **Y** then press Enter.

Intel(R) Management Engine BIOS Extension v8.0.0.0061/Intel(R) ME v8.0.4.1441
Copyright(C) 2003-12 Intel Corporation. All Rights Reserved.

INTEL (R) AUTOMATED SETUP AND CONFIGURATION

Set PID and PPS **

Delete PID and PPS **

CAUTION:
This will delete the PID and PPS entries.
Continue: (Y/N)

[↑↓] = Move highlight [ENTER] = Select Entry [ESC]= Exit

47. Select Previous Menu until you return to the **Main Menu**. Select **Exit** then press Enter. Type **Y** then press Enter.

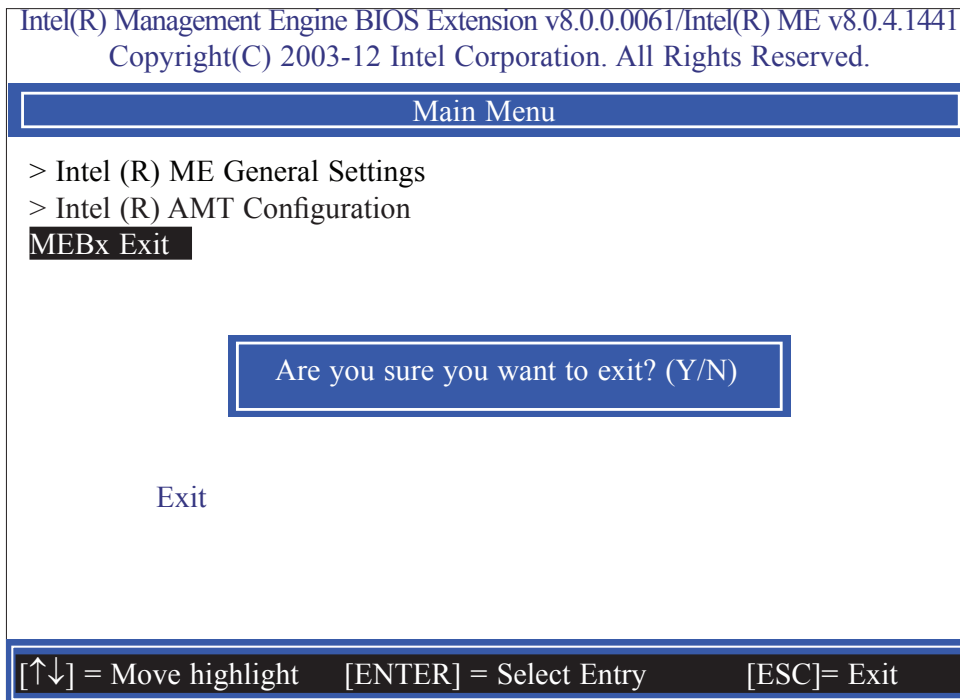

Appendix A - NLITE and AHCI Installation Guide

nLite

nLite is an application program that allows you to customize your XP installation disc by integrating the RAID/AHCI drivers into the disc. By using nLite, the F6 function key usually required during installation is no longer needed.



Note:

The installation steps below are based on nLite version 1.4.9. Installation procedures may slightly vary if you're using another version of the program.

1. Download the program from nLite's official website.

<http://www.nliteos.com/download.html>

2. Install nLite.



Important:

Due to its coding with Visual.Net, you may need to first install .NET Framework prior to installing nLite.

3. Download relevant RAID/AHCI driver files from Intel's website. The drivers you choose will depend on the operating system and chipset used by your computer.

The downloaded driver files should include iaahci.cat, iaAHCI.inf, iastor.cat, iaStor.inf, IaStor.sys, license.txt and TXTSETUP.OEM.

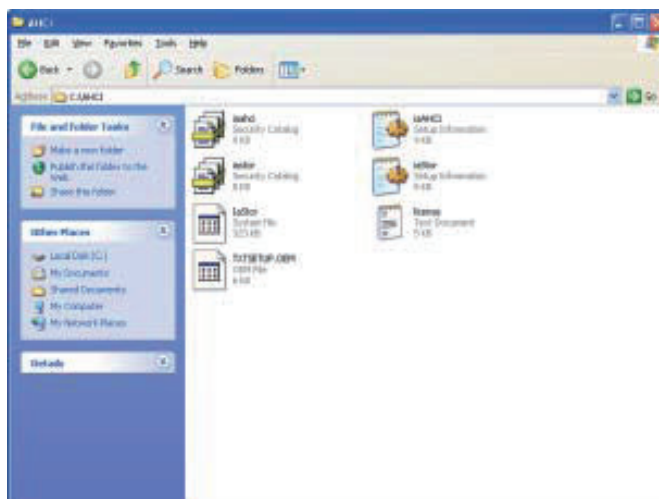

4. Insert the XP installation disc into an optical drive.
5. Launch nLite. The Welcome screen will appear. Click **Next**.

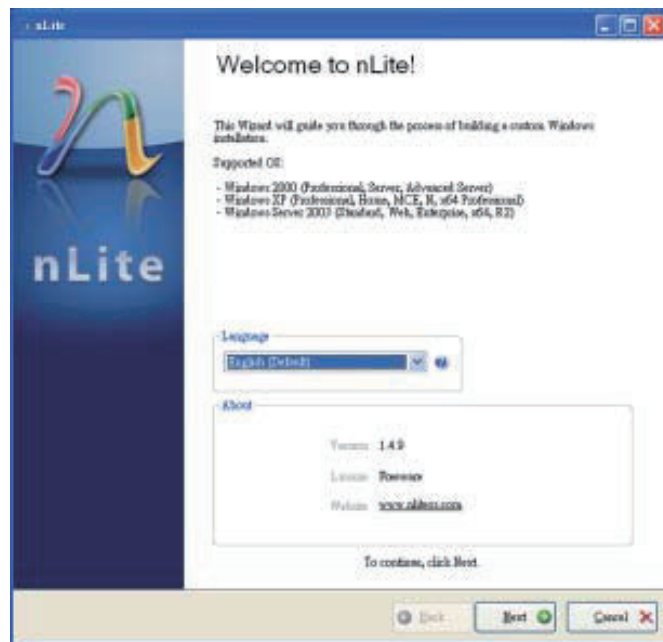

6. Click **Next** to temporarily save the Windows installation files to the designated default folder.

If you want to save them in another folder, click **Browse**, select the folder and then click **Next**.

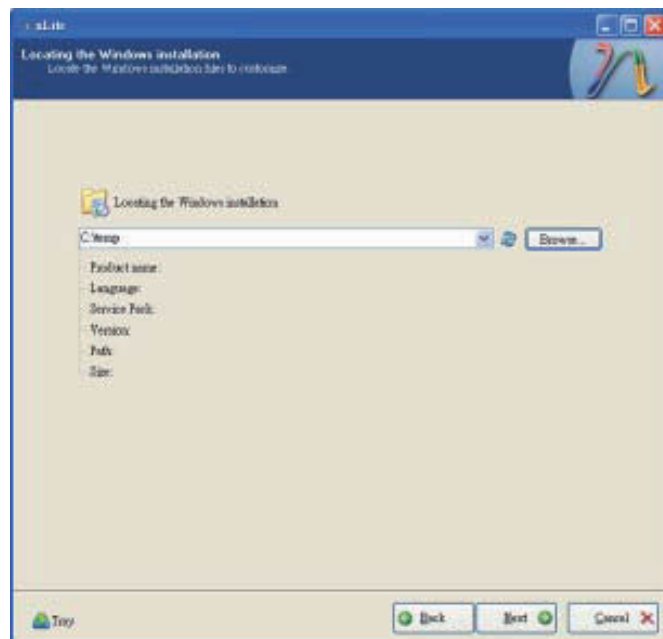

7. Click **Next**.

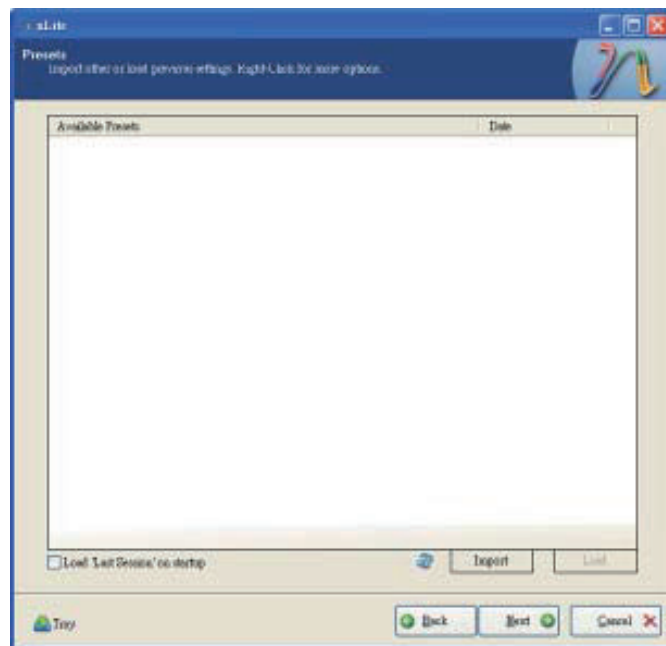

8. In the Task Selection dialog box, click **Drivers** and **Bootable ISO**. Click **Next**.

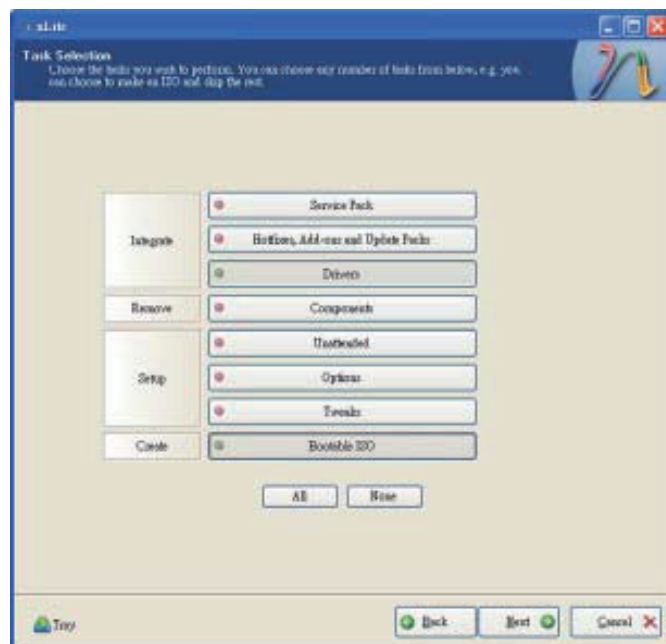

- Click **Insert** and then select **Multiple driver folder** to select the drivers you will integrate. Click **Next**.

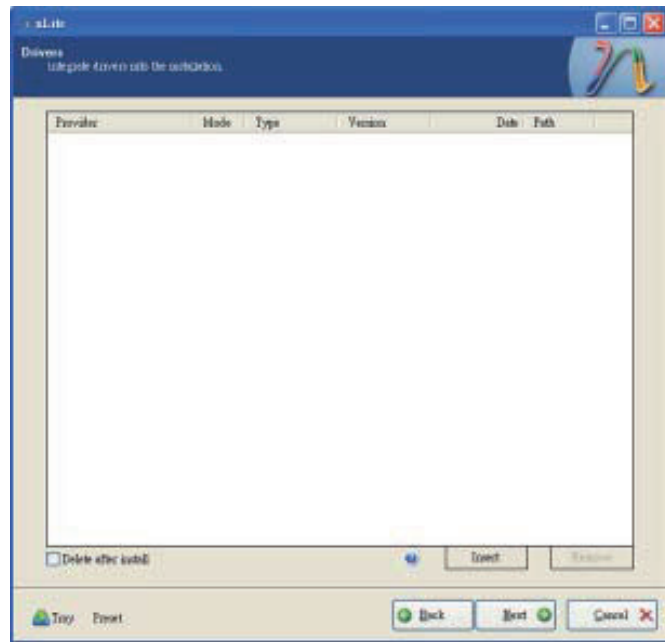

- Select only the drivers appropriate for the Windows version that you are using and then click **OK**.

Integrating 64-bit drivers into 32-bit Windows or vice versa will cause file load errors and failed installation.

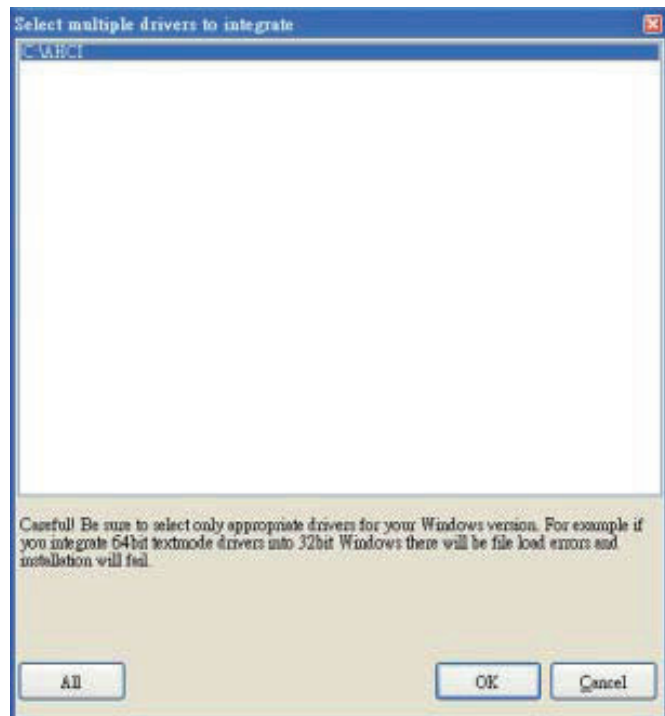

- If you are uncertain of the southbridge chip used on your motherboard, select all RAID/AHCI controllers and then click **OK**.

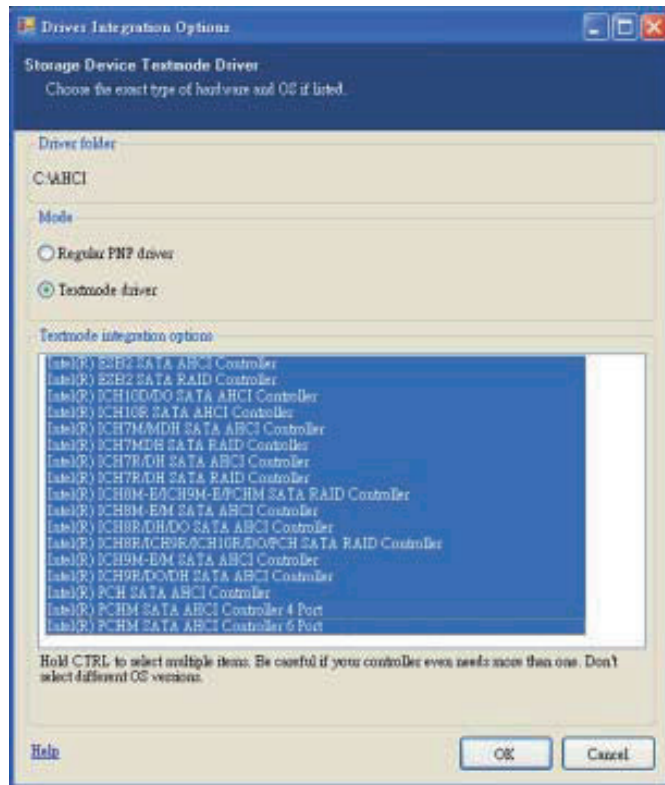

- Click **Next**.

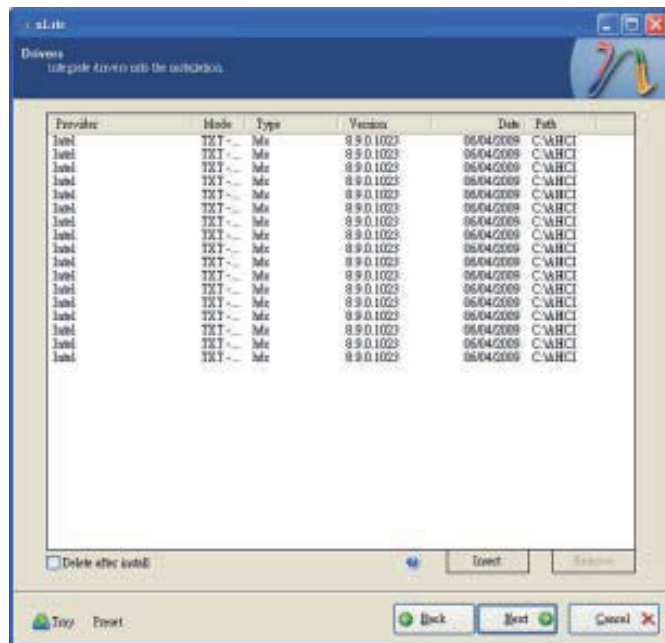

13. The program is currently integrating the drivers and applying changes to the installation.

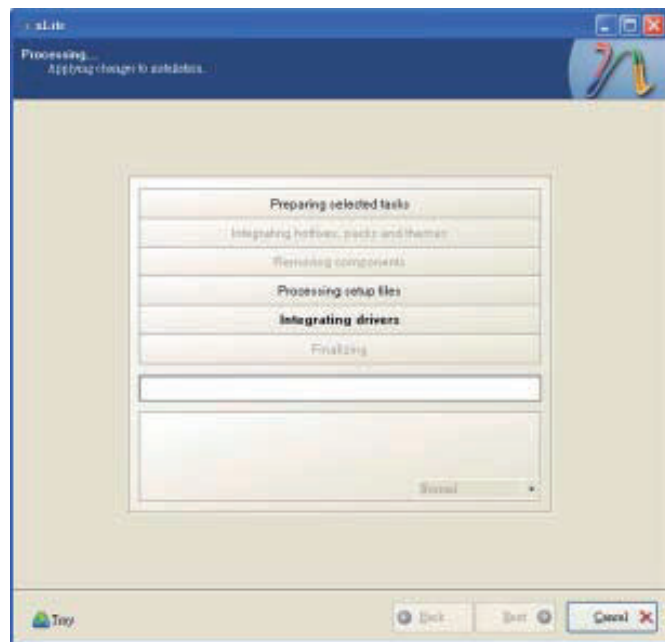

14. When the program is finished applying the changes, click **Next**.

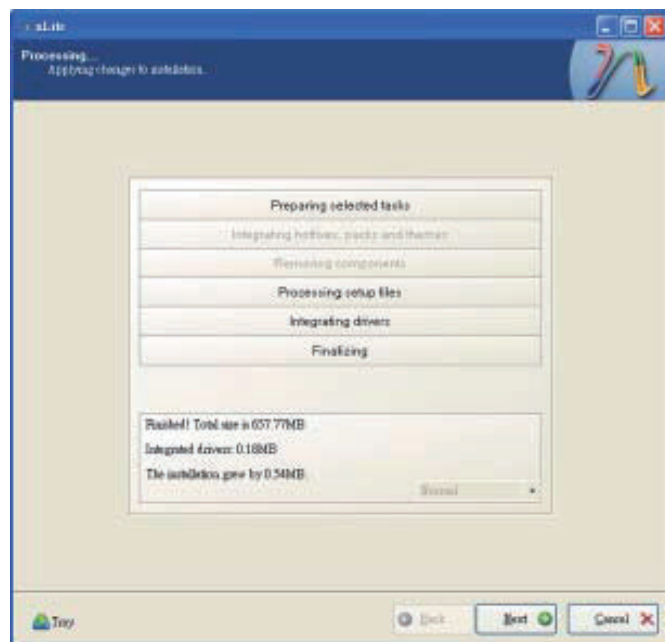

15. To create an image, select the **Create Image** mode under the General section and then click **Next**.

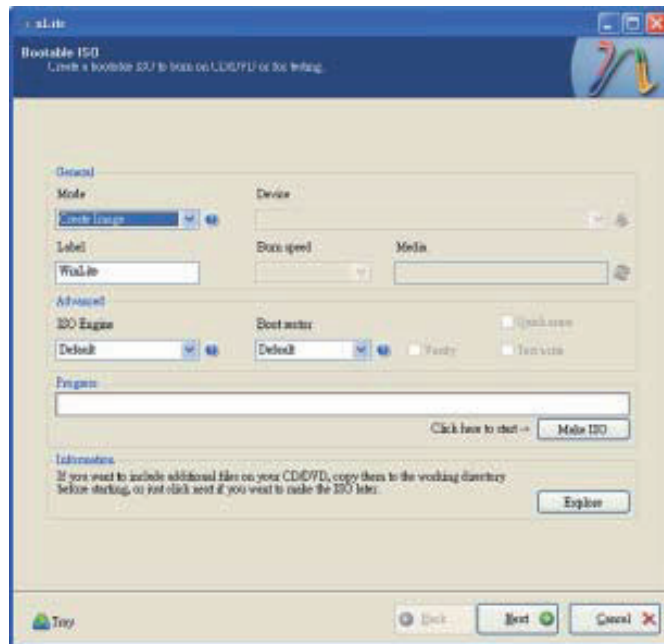

16. Or you can choose to burn it directly to a disc by selecting the **Direct Burn** mode under the General section.

Select the optical device and all other necessary settings and then click **Next**.

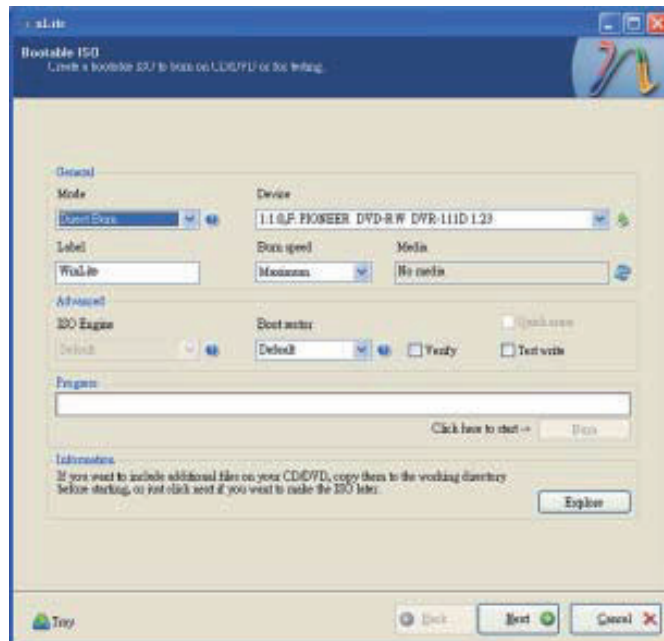

17. You have finished customizing the Windows XP installation disc. Click **Finish**.

Enter the BIOS utility to configure the SATA controller to RAID/AHCI. You can now install Windows XP.

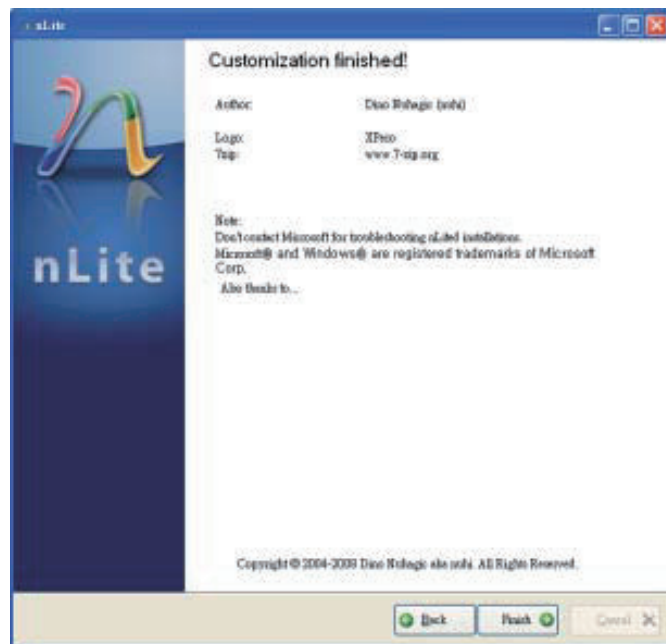

AHCI

The installation steps below will guide you in configuring your SATA drive to AHCI mode.

1. Enter the BIOS utility and configure the SATA controller to IDE mode.
2. Install Windows XP but do not press F6.
3. Download relevant RAID/AHCI driver files supported by the motherboard chipset from Intel's website.

Transfer the downloaded driver files to C:\AHCI.

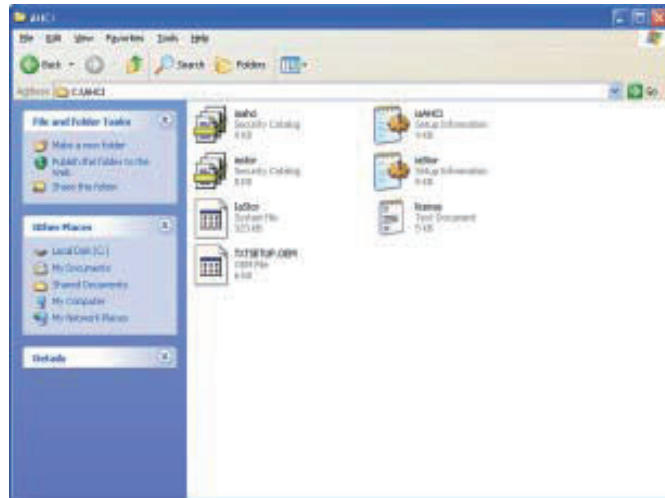

4. Open Device Manager and right click on one of the Intel Serial ATA Storage Controllers, then select **Update Driver**.

If the controller you selected did not work, try selecting another one.

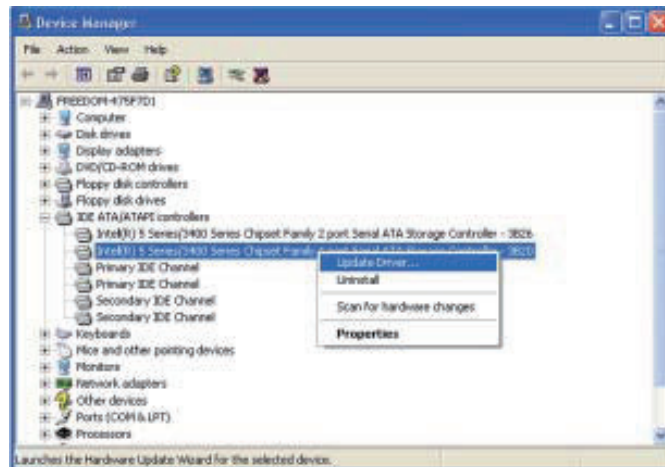

5. In the Hardware Update Wizard dialog box, select **“No, not this time”** then click **Next**.



6. Select **“Install from a list or specific location (Advanced)”** and then click **Next**.

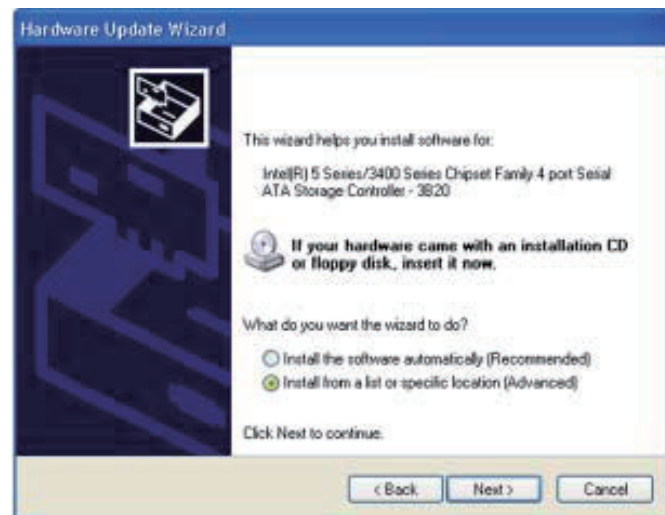

7. Select **“Don't search. I will choose the driver to install”** and then click **Next**.

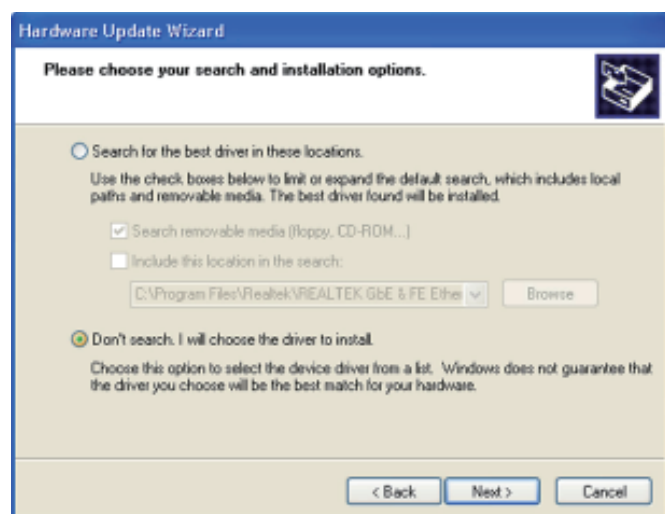

- Click **"Have Disk"**.

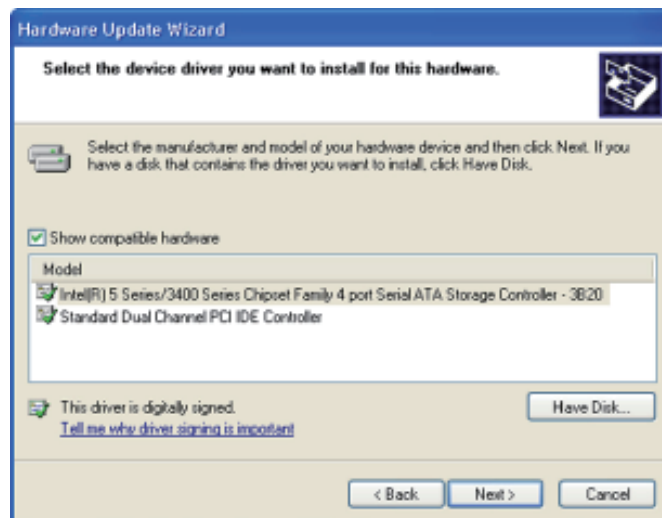

- Select C:\AHCI\iaAHCI.inf and then click **Open**.

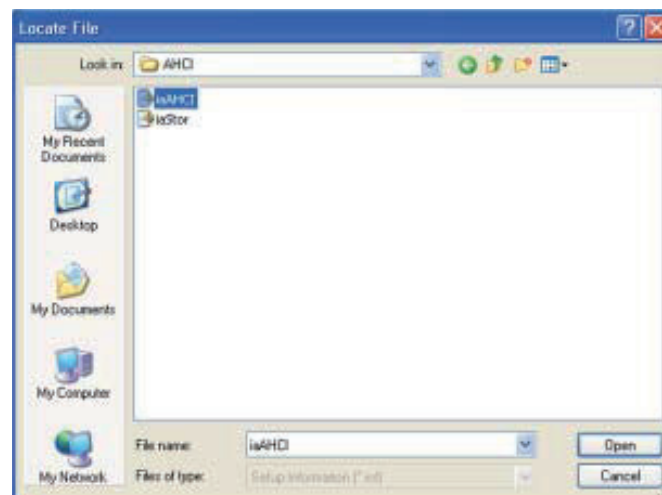

- Select the appropriate AHCI Controller of your hardware device and then click **Next**.

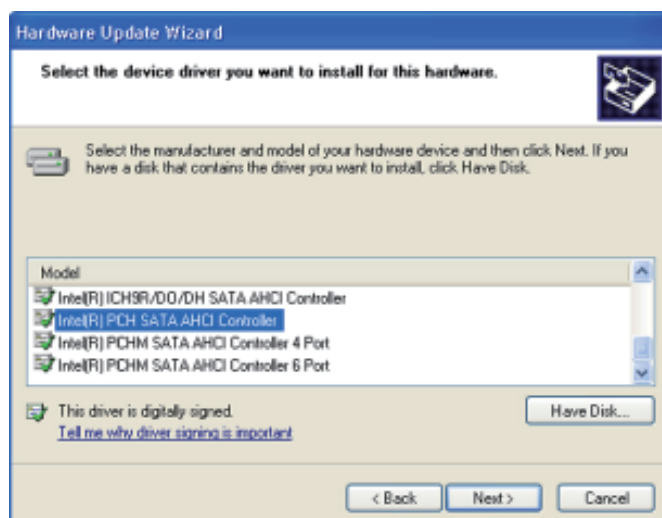

11. A warning message appeared because the selected SATA controller did not match your hardware device.

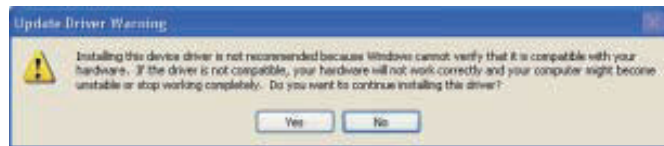

Ignore the warning and click **Yes** to proceed.

12. Click **Finish**.

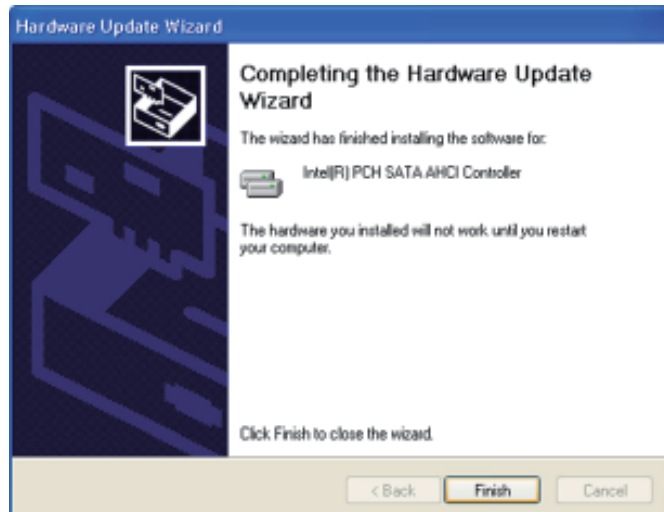

13. The system's settings have been changed. Windows XP requires that you restart the computer. Click **Yes**.

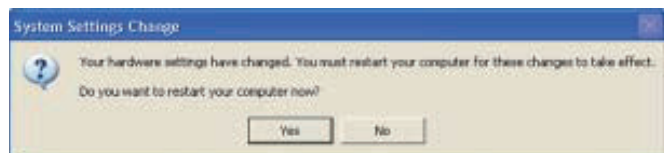

14. Enter the BIOS utility and modify the SATA controller from IDE to AHCI. By doing so, Windows will work normally with the SATA controller that is in AHCI mode.

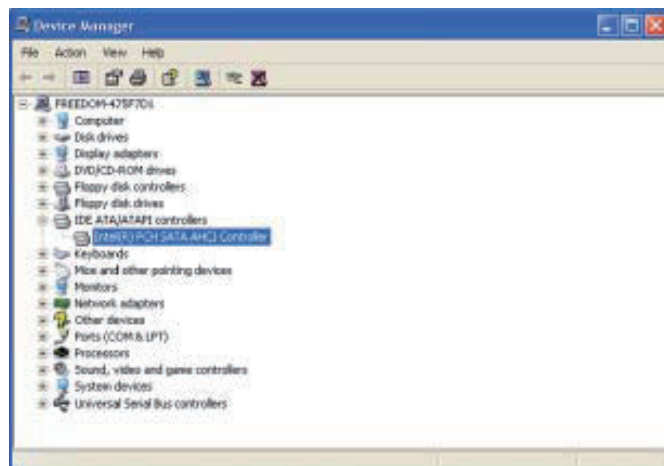

Appendix B - Watchdog Sample Code

;Software programming example:

```
-----  
;(1) Enter Super IO Configuration mode  
-----  
MOV     DX,2EH  
MOV     AL,87H  
OUT     DX,AL  
OUT     DX,AL  
  
-----  
;(2) Configuration Logical Device 7, register CRF5/CRF6 (WDT Control /WDT  
timer)  
-----  
MOV     DX,2EH  
MOV     AL,07H           ;Ready to Program Logical Device  
OUT     DX,AL  
  
MOV     DX,2FH  
MOV     AL,07H           ;Select Logical Device 7  
OUT     DX,AL  
  
MOV     DX,2EH  
MOV     AL, F6H           ;Select watchdog timer register  
OUT     DX,AL  
  
MOV     DX,2FH  
MOV     AL,10H           ;Set watchdog timer value  
OUT     DX,AL  
  
MOV     DX,2EH  
MOV     AL, F5H           ;Select watchdog Control Register  
OUT     DX,AL  
  
MOV     DX,2FH  
MOV     AL,61H           ;Set Watchdog Control Value  
OUT     DX,AL  
  
-----  
;(1) Exit extended function mode  
-----  
MOV     DX,2EH  
MOV     AL,AAH  
OUT     DX,AL
```

Appendix C - System Error Message

When the BIOS encounters an error that requires the user to correct something, either a beep code will sound or a message will be displayed in a box in the middle of the screen and the message, PRESS F1 TO CONTINUE, CTRL-ALT-ESC or DEL TO ENTER SETUP, will be shown in the information box at the bottom. Enter Setup to correct the error.

Error Messages

One or more of the following messages may be displayed if the BIOS detects an error during the POST. This list indicates the error messages for all Awards BIOSes:

CMOS BATTERY HAS FAILED

The CMOS battery is no longer functional. It should be replaced.



Important

Danger of explosion if battery incorrectly replaced. Replace only with the same or equivalent type recommended by the manufacturer. Dispose of used batteries according to the battery manufacturer's instructions.

CMOS CHECKSUM ERROR

Checksum of CMOS is incorrect. This can indicate that CMOS has become corrupt. This error may have been caused by a weak battery. Check the battery and replace if necessary.

DISPLAY SWITCH IS SET INCORRECTLY

The display switch on the motherboard can be set to either monochrome or color. This indicates the switch is set to a different setting than indicated in Setup. Determine which setting is correct, either turn off the system and change the jumper or enter Setup and change the VIDEO selection.

FLOPPY DISK(S) fail (80)

Unable to reset floppy subsystem.

FLOPPY DISK(S) fail (40)

Floppy type mismatch.

Hard Disk(s) fail (80)

HDD reset failed.

Hard Disk(s) fail (40)

HDD controller diagnostics failed.

Hard Disk(s) fail (20)

HDD initialization error.

Hard Disk(s) fail (10)

Unable to recalibrate fixed disk.

Hard Disk(s) fail (08)

Sector Verify failed.

Keyboard is locked out - Unlock the key

The BIOS detects that the keyboard is locked. Keyboard controller is pulled low.

Keyboard error or no keyboard present

Cannot initialize the keyboard. Make sure the keyboard is attached correctly and no keys are being pressed during the boot.

Manufacturing POST loop

System will repeat POST procedure infinitely while the keyboard controller is pulled low. This is also used for the M/B burn in test at the factory.

BIOS ROM checksum error - System halted

The checksum of ROM address F0000H-FFFFFFH is bad.

Memory test fail

The BIOS reports memory test fail if the memory has error(s).

Appendix D - Troubleshooting

Troubleshooting Checklist

This chapter of the manual is designed to help you with problems that you may encounter with your personal computer. To efficiently troubleshoot your system, treat each problem individually. This is to ensure an accurate diagnosis of the problem in case a problem has multiple causes.

Some of the most common things to check when you encounter problems while using your system are listed below.

1. The power switch of each peripheral device is turned on.
2. All cables and power cords are tightly connected.
3. The electrical outlet to which your peripheral devices are connected is working. Test the outlet by plugging in a lamp or other electrical device.
4. The monitor is turned on.
5. The display's brightness and contrast controls are adjusted properly.
6. All add-in boards in the expansion slots are seated securely.
7. Any add-in board you have installed is designed for your system and is set up correctly.

Monitor/Display

If the display screen remains dark after the system is turned on:

1. Make sure that the monitor's power switch is on.
2. Check that one end of the monitor's power cord is properly attached to the monitor and the other end is plugged into a working AC outlet. If necessary, try another outlet.
3. Check that the video input cable is properly attached to the monitor and the system's display adapter.
4. Adjust the brightness of the display by turning the monitor's brightness control knob.

The picture seems to be constantly moving.

1. The monitor has lost its vertical sync. Adjust the monitor's vertical sync.
2. Move away any objects, such as another monitor or fan, that may be creating a magnetic field around the display.
3. Make sure your video card's output frequencies are supported by this monitor.

The screen seems to be constantly wavering.

1. If the monitor is close to another monitor, the adjacent monitor may need to be turned off. Fluorescent lights adjacent to the monitor may also cause screen wavering.

Power Supply

When the computer is turned on, nothing happens.

1. Check that one end of the AC power cord is plugged into a live outlet and the other end properly plugged into the back of the system.
2. Make sure that the voltage selection switch on the back panel is set for the correct type of voltage you are using.
3. The power cord may have a "short" or "open". Inspect the cord and install a new one if necessary.

Floppy Drive

The computer cannot access the floppy drive.

1. The floppy diskette may not be formatted. Format the diskette and try again.
2. The diskette may be write-protected. Use a diskette that is not write-protected.
3. You may be writing to the wrong drive. Check the path statement to make sure you are writing to the targeted drive.
4. There is not enough space left on the diskette. Use another diskette with adequate storage space.

Hard Drive

Hard disk failure.

1. Make sure the correct drive type for the hard disk drive has been entered in the BIOS.
2. If the system is configured with two hard drives, make sure the bootable (first) hard drive is configured as Master and the second hard drive is configured as Slave. The master hard drive must have an active/bootable partition.

Excessively long formatting period.

If your hard drive takes an excessively long period of time to format, it is likely a cable connection problem. However, if your hard drive has a large capacity, it will take a longer time to format.

Serial Port

The serial device (modem, printer) doesn't output anything or is outputting garbled characters.

1. Make sure that the serial device's power is turned on and that the device is on-line.
2. Verify that the device is plugged into the correct serial port on the rear of the computer.
3. Verify that the attached serial device works by attaching it to a serial port that is working and configured correctly. If the serial device does not work, either the cable or the serial device has a problem. If the serial device works, the problem may be due to the onboard I/O or the address setting.
4. Make sure the COM settings and I/O address are configured correctly.

Keyboard

Nothing happens when a key on the keyboard was pressed.

1. Make sure the keyboard is properly connected.
2. Make sure there are no objects resting on the keyboard and that no keys are pressed during the booting process.

System Board

1. Make sure the add-in card is seated securely in the expansion slot. If the add-in card is loose, power off the system, re-install the card and power up the system.
2. Check the jumper settings to ensure that the jumpers are properly set.
3. Verify that all memory modules are seated securely into the memory sockets.
4. Make sure the memory modules are in the correct locations.
5. If the board fails to function, place the board on a flat surface and seat all socketed components. Gently press each component into the socket.
6. If you made changes to the BIOS settings, re-enter setup and load the BIOS defaults.